

Алматы (7273)495-231  
Ангарск (3955)60-70-56  
Архангельск (8182)63-90-72  
Астрахань (8512)99-46-04  
Барнаул (3852)73-04-60  
Белгород (4722)40-23-64  
Благовещенск (4162)22-76-07  
Брянск (4832)59-03-52  
Владивосток (423)249-28-31  
Владикавказ (8672)28-90-48  
Владимир (4922)49-43-18  
Волгоград (844)278-03-48  
Вологда (8172)26-41-59  
Воронеж (473)204-51-73  
Екатеринбург (343)384-55-89

Иваново (4932)77-34-06  
Ижевск (3412)26-03-58  
Иркутск (395)279-98-46  
Казань (843)206-01-48  
Калининград (4012)72-03-81  
Калуга (4842)92-23-67  
Кемерово (3842)65-04-62  
Киров (8332)68-02-04  
Коломна (4966)23-41-49  
Кострома (4942)77-07-48  
Краснодар (861)203-40-90  
Красноярск (391)204-63-61  
Курск (4712)77-13-04  
Курган (3522)50-90-47  
Липецк (4742)52-20-81

Магнитогорск (3519)55-03-13  
Москва (495)268-04-70  
Мурманск (8152)59-64-93  
Набережные Челны (8552)20-53-41  
Нижний Новгород (831)429-08-12  
Новокузнецк (3843)20-46-81  
Ноябрьск (3496)41-32-12  
Новосибирск (383)227-86-73  
Омск (3812)21-46-40  
Орел (4862)44-53-42  
Оренбург (3532)37-68-04  
Пенза (8412)22-31-16  
Петрозаводск (8142)55-98-37  
Псков (8112)59-10-37  
Пермь (342)205-81-47

Ростов-на-Дону (863)308-18-15  
Рязань (4912)46-61-64  
Самара (846)206-03-16  
Санкт-Петербург (812)309-46-40  
Саратов (845)249-38-78  
Севастополь (8692)22-31-93  
Саранск (8342)22-96-24  
Симферополь (3652)67-13-56  
Смоленск (4812)29-41-54  
Сочи (862)225-72-31  
Ставрополь (8652)20-65-13  
Сургут (3462)77-98-35  
Сыктывкар (8212)25-95-17  
Тамбов (4752)50-40-97  
Тверь (4822)63-31-35

Тольятти (8482)63-91-07  
Томск (3822)98-41-53  
Тула (4872)33-79-87  
Тюмень (3452)66-21-18  
Ульяновск (8422)24-23-59  
Улан-Удэ (3012)59-97-51  
Уфа (347)229-48-12  
Хабаровск (4212)92-98-04  
Чебоксары (8352)28-53-07  
Челябинск (351)202-03-61  
Череповец (8202)49-02-64  
Чита (3022)38-34-83  
Якутск (4112)23-90-97  
Ярославль (4852)69-52-93

Россия +7(495)268-04-70

Казахстан +7(7172)727-132

Киргизия +996(312)96-26-47

<https://liv.nt-rt.ru/> || [vis@nt-rt.ru](mailto:vis@nt-rt.ru)

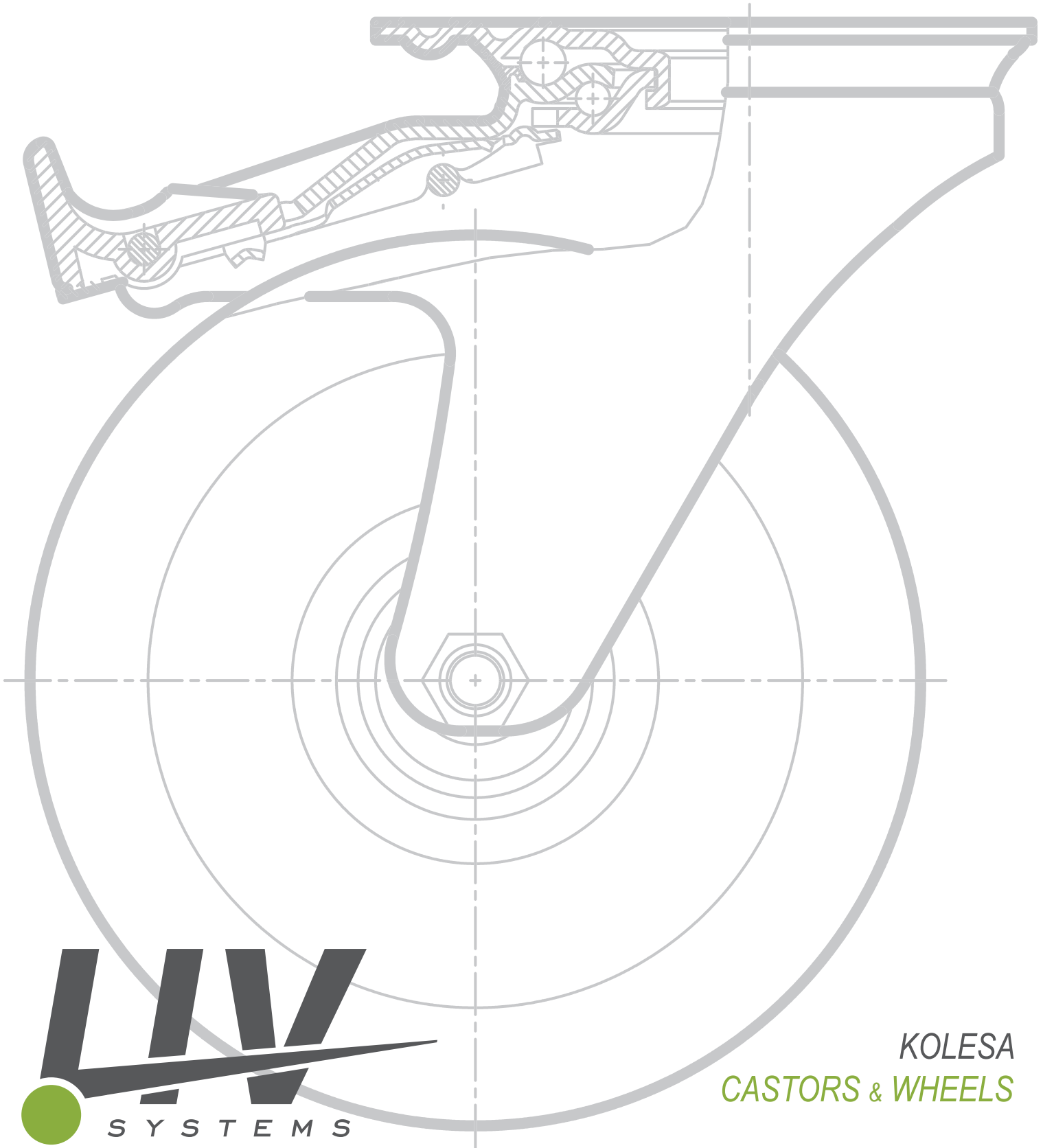

KOLESA  
CASTORS & WHEELS



V PROIZVODNEM PROGRAMU  
IMAMO PREKO 1600 RAZLIČNIH KOMBINACIJ KOLES  
IN VSA SE VRTIJO V ZADOVOLJSTVO  
MILIJONOV ZVESTIH UPORABNIKOV  
PO VSEM SVETU.

OUR PRODUCTION LINE  
CONSISTS OF OVER 1600 DIFFERENT WHEEL COMBINATIONS.  
ALL OF THEM SPIN TO THE SATISFACTION  
OF MILLIONS OF FAITHFUL USERS  
AROUND THE GLOBE.

NAŠA KOLESA SE VRTIJO V VAŠE ZADOVOLJSTVO  
OUR WHEELS SPIN TO YOUR SATISFACTION



<b>1</b>	<b>KOLESA ZA SPLOŠNE NAMENE CASTORS AND WHEELS FOR STANDARD USE</b>	<b>10</b>
<b>2</b>	<b>KOLESA IZ NERJAVEČE PLOČEVINE STAINLESS STEEL CASTORS AND WHEELS</b>	<b>34</b>
<b>3</b>	<b>KOLESA ZA KONTEJNERJE CASTORS AND WHEELS FOR MOBILE WASTE CONTAINERS</b>	<b>50</b>
<b>4</b>	<b>KOLESA ZA TEŽJE DELOVNE POGOJE HEAVY DUTY CASTORS AND WHEELS</b>	<b>56</b>
<b>5</b>	<b>KOLESA ZA NERAVNA TLA CASTORS AND WHEELS FOR ROUGH FLOORS</b>	<b>70</b>
<b>6</b>	<b>KOLESA ZA USTANOVE INSTITUTIONAL CASTORS AND WHEELS</b>	<b>80</b>
<b>7</b>	<b>KOLESA ZA POHIŠTVO CASTORS AND WHEELS FOR FURNITURE</b>	<b>86</b>
<b>8</b>	<b>TEMPERATURNO ODPORNA KOLESA HEAT RESISTANT CASTORS AND WHEELS</b>	<b>94</b>
<b>9</b>	<b>POSEBNE IZVEDBE KOLES CASTORS AND WHEELS FOR SPECIAL REQUIREMENTS</b>	<b>98</b>

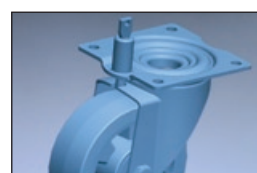
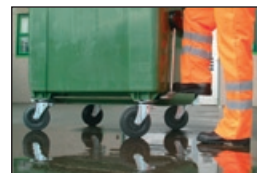

- 1
- 2
- 3
- 4
- 5
- 6
- 7
- 8
- 9



S tem katalogom vam predstavljamo naš standardni program koles, katerega smo razvijali več let in vanj vnesli naše dolgoletne izkušnje. S stalnim izpopolnjevanjem in uvajanjem novih oblik ter z dvigom kvalitete skrbimo za naš sodoben in kvaliteten asortiman. Vse naše odjemalce bi radi seznanili z nekaterimi, za določitev kolesa važnimi podatki in jim tako pomagali pri pravilni izbiri posameznih vrst koles. Pri tej izbiri vam lahko pomaga tudi naša tehniška služba.

## RAZVRSTITEV KOLES

Osnovna funkcijska razvrstitev:

- kolesa brez vilic
- kolesa z gibljivimi vilicami
- kolesa s stabilnimi vilicami

Nadaljnje delitve glede na vrsto vleženja, obloge, platišča in pritrditve so razvidne iz posameznih tabel.

## NOSILNOST KOLES

Pri izbiri koles, glede nosilnosti morate biti pazljivi na naslednje točke:

- Namestitev koles na vozičku in določitev števila K.

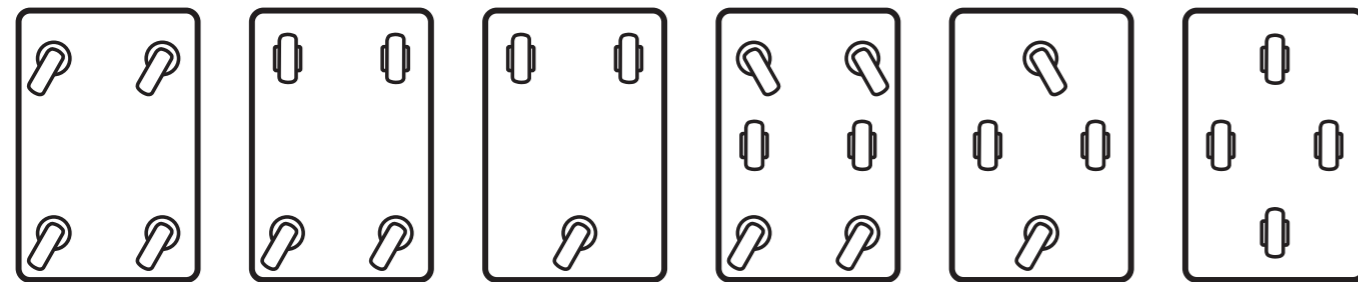

$$\text{Obremenitev kolesa} = \frac{\text{teža tovora} + \text{teža vozila}}{K}$$

This catalog presents our standard program of castors and wheels, which we have been developing for years and where we have capitalized on our long-term experience. Constant perfection and introduction of new shapes and rising quality level guarantee the quality of our up-to-date assortment. On the following pages we would like to propose some technical definitions to help our consumers make the right choice of the most suitable castor or wheel according to purpose of use. Our technical service is always available for further information.

## CLASSIFICATION OF CASTORS AND WHEELS

Elementary functional classification:

- wheels
- swivel castors
- fixed castors

Further divisions as regards the type of the bearing, tread, wheel centre and housing are evident from the particular tabels.

## LOAD CAPACITY OF CASTORS AND WHEELS

When choosing wheels as to their load capacity the following must be considered:

- Positioning the wheels or castors on the vehicle (choose the number K according to the pictures).

$$\text{Load per wheel or per castor} = \frac{\text{weight of the vehicle} + \text{load to be carried}}{K}$$

Load capacities in the catalogue have been defined in line with the results of tests performed according to standard DIN EN 12527 Castors and wheels – Test methods and apparatus, these are values for dynamic load capacity at ambient temperature 20°C and other conditions detailed in standards for different purposes of use.

Depending on their purpose of use, castors and wheels are in conformity with one of the following standards:

- EN 840-5:2004 Mobile waste containers – Part 5: Performance requirements and test methods.
- DIN EN 12528:1999 Castors and wheels -Castors for furniture – Requirements.
- DIN EN 12529:1999 Castors for furniture – Castors for swivel chairs – Requirements.
- EN 12530:1998 Castors and wheels – castors and wheels for manually propelled institutional applications

- EN 840-5:2004 Mobile waste containers – Part 5: Performance requirements and test methods.
- DIN EN 12528:1999 Castors and wheels -Castors for furniture – Requirements.
- DIN EN 12529:1999 Castors for furniture – Castors for swivel chairs – Requirements.
- EN 12530:1998 Castors and wheels – castors and wheels for manually propelled institutional applications

- EN 12532:1998 Castors and wheels – Castors and wheels for applications up to 1,1m/s (4 km/h).
- EN 12533:1998 Castors and wheels – Castors and wheels for applications over 1,1m/s (4 km/h) and up to 4,4 m/s (16 km/h).

Večje dinamične obremenitve in trenutne preobremenitve zaradi:

- udarcev
- padcev
- hrapavih ali neravnih tal
- vožnje preko ovir
- višjih hitrosti
- bočnih obremenitev
- višjih oz. nižjih temperatur
- vplivov kemičnih snovi

je potrebno upoštevati pri izbiri kolesa. V teh primerih kolo ne sme biti obremenjeno do nazivne nosilnosti ali pa je potrebno izbrati kolo z večjo nosilnostjo!

## KARAKTERISTIKE POSAMEZNIH VRST LEŽAJEV

- **Drсни ležaj:** nezahtevno vzdrževanje, neobčutljiv na udarce, primeren za uporabo v vlažnih prostorih, za manjše hitrosti.
- **Valjni ležaj:** vzdržljiv, nezahtevno vzdrževanje, neobčutljiv na udarce, za manjše hitrosti.
- **Kroglični ležaj:** lahkotekoč tudi pri večjih obremenitvah in hitrostih, primeren za pogosto obratovanje.

## KARAKTERISTIKE KOLES IN OBLOGE KOLES

- **Guma + PASE :** miren tek in majhne vibracije pri transportu, upor pri vožnji manjši kot pri pnevmatiki.
- **Poliuretan obloga:** visoke nosilnosti, majhna obraba, miren tek, neobčutljiva na ostre kovinske delce, neodporna na vročo vodo in paro.
- **Pnevmatika:** izjemno dušenje udarcev in majhen odpor pri vožnji po neravnem terenu.
- **Poliamid in polipropilen:** neobčutljiv na mokroto in mnoge kisline, sorazmerno velike nosilnosti, primeren za gladka tla.
- **Bakelit + PATO:** visoke nosilnosti, temperaturna obstojnost do 270°C. Zelo primeren za peči in sušilnice. Bakelitna kolesa so omejena samo na uporabo po ravnih in gladkih tleh.
- **Litoželezna:** visoke nosilnosti, majhna obraba, visoka temperaturna obstojnost, slabša amortizacija udarcev.

## ELEKTRIČNA PREVODNOST

Glede na vaše potrebe izdelamo kolesa, katera so lahko:

- **električno prevodna:**  $R \leq 10^4 \Omega$
- **odvajajo statično elektriko:**  $R \leq 10^7 \Omega$

- EN 12532:1998 Castors and wheels – Castors and wheels for applications up to 1,1m/s (4 km/h).
- EN 12533:1998 Castors and wheels – Castors and wheels for applications over 1,1m/s (4 km/h) and up to 4,4 m/s (16 km/h).

Greater dynamic loads and temporary overloads due to:

- strokes
- falls
- rough or uneven floor
- rolling over obstacles
- higher speed
- side impacts
- higher or lower temperatures
- influence of chemical substances

have to be considered when choosing the right castor or wheel. In this case, the castor or wheel must not be loaded up to its nominal load capacity, otherwise you have to choose a castor or a wheel with a greater load capacity.

## CHARACTERISTICS OF SPECIFIC BEARING

- **Plain bearing:** simple maintenance, nonreactive to blows, suitable for usage in damp places, for slower speed.
- **Roller bearing:** persistent, simple maintenance, non-reactive to blows, for slower speed.
- **Ball bearing:** easy moved also at greater loads and higher speed, suitable for frequent operation.

## CHARACTERISTICS OF TYRE, TREAD OR SOLID WHEEL

- **Solid rubber tyre:** smooth run, small vibrations at transport, resistance while driving is smaller than with a pneumatic tyre.
- **Polyurethane tread:** large carrying capacity, small wear, smooth run, nonreactive to sharp metal splinters, irresistible to hot water and steam.
- **Pneumatic:** extreme damping of blows and little resistance on an uneven surface.
- **Polyamide and polypropylene solid wheel:** nonreactive to moisture and many acids, relatively large carrying capacity, suitable for smooth surfaces.
- **Phenolic solid wheel:** large load capacity, continuous temperature resistance up to 270°C. Very appropriate for bakeries and drying ovens. Phenolic wheels should not be used on an uneven floors (edges, obstacles) or rough floors.
- **Cast iron solid wheel:** large load capacity, small wear, very high temperature resistance, weaker damping of blows.

## ELECTRICAL RESISTANCE

In addition to the standard version, the following are available:

- **Conductive castor or wheel:**  $R \leq 10^4 \Omega$
- **Antistatic castor or wheel:**  $R \leq 10^7 \Omega$

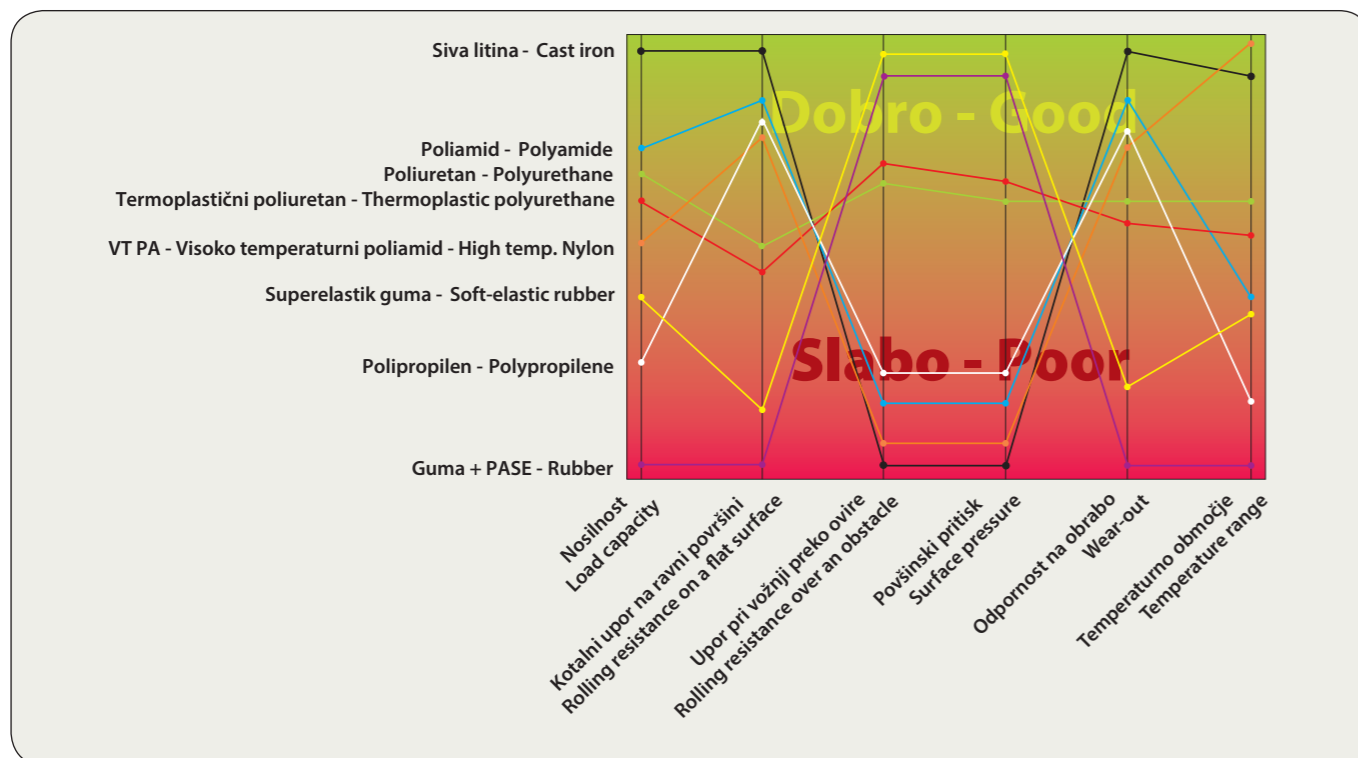

### OBSTOJNOST NA TEMPERATURO

V katalogu definirane nosilnosti veljajo v temperaturnem območju **Tn**. Vendar pa je delovna temperatura **To** koles lahko višja ali nižja, pri čemer je potrebno upoštevati manjšo nosilnost koles. Nosilnost koles se spreminjanja sorazmerno s spreminjanjem temperature. Za nekatere materiale so dovoljene kratkotrajne višje temperature **Tt**, vendar je pri tem potrebno upoštevati manjšo nosilnost kolesa!

### TEMPERATURE CONSTANCY

Castors and wheels load capacity declared in the catalogue is valid in the temperature range **Tn**. The operating temperature range **To** for the wheels can vary, depending on a smaller load capacity. Load capacity is changing in accordance with temperature changes. Some wheel materials temporarily resist to higher temperatures **Tt**, but smaller load capacity has to be considered!

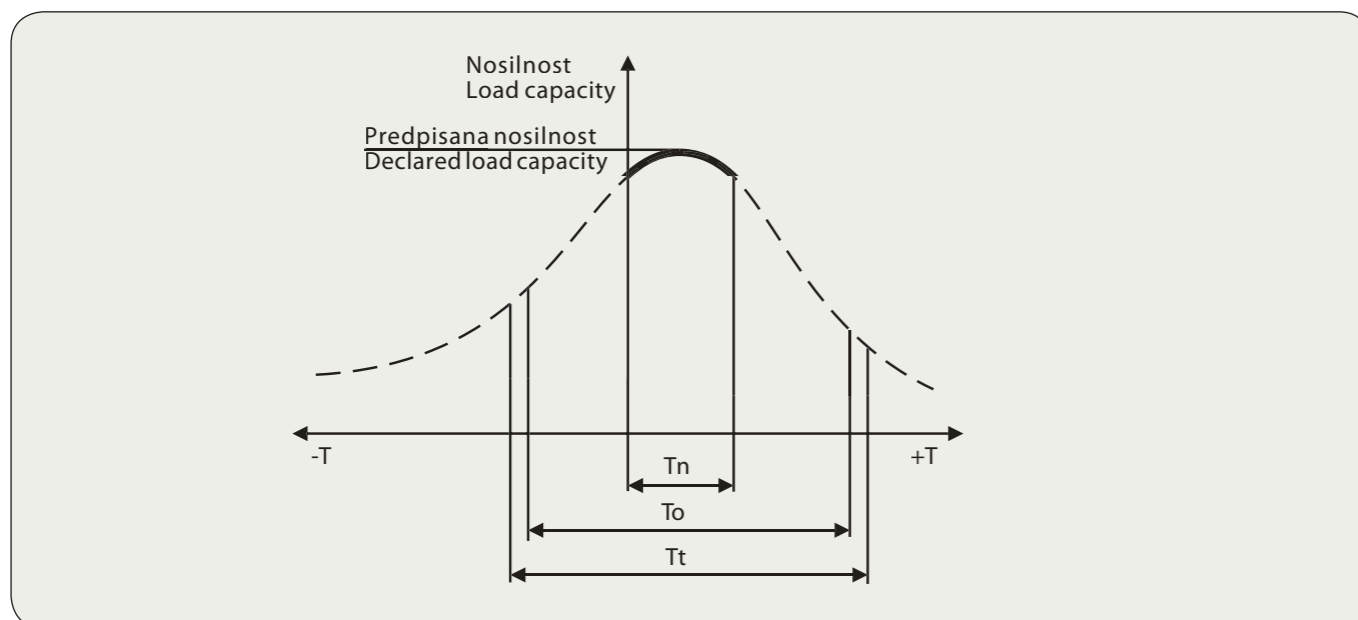

Materiali koles	Materials of wheels	Tn		To*		Tt*	
		T za predpisano nosilnost T for declared load capacity		Delovna temperatura Operating temperature		Kratkotrajna (10 min) višja temp. Temporarily (10 min) higher temp.	
Guma	Rubber	0°C	+30°C	-20°C	+70°C	-30°C	+80°C
Poliuretani (TPU)	Polyurethane (TPU)	0°C	+40°C	-20°C	+80°C	-40°C	+100°C
Poliuretani **	Polyurethane **	0°C	+45°C	-25°C	+55°C	-40°C	+55°C
Polipropilen	Polypropylene	0°C	+30°C	-20°C	+60°C	/	/
Poliamid **	Polyamide **	0°C	+40°C	-25°C	+80°C	-30°C	+110°C
Visokotemperaturni poliamid	High temperature polyamide	-25°C	+250°C	-25°C	+250°C	-40°C	+300°C

\* upoštevati manjšo nosilnost!

\*\* na željo uporabnika lahko nekatera kolesa izdelamo iz poliamida ali poliuretana za višje temperature.

\* considering smaller load capacity!

\*\* on customer's request some polyamide and polyurethane wheels can be made of high temperature material.

### ODPORNOST PROTI KEMIKALIJAM

Oznake pomenijo:

✓ odporno      O delno odporno      - neodporno

The signs denote:

✓ resistant      O partly resistant      - non resistant

Vrsta kemikalije	The sort chemicals	Guma + PASE Rubber	Poliuretani Polyurethane	Polipropilen Polypropylene	Poliamid Polyamide	VT PA High temp. Nylon
Etanol	Ethanol	✓	✓	O	✓	✓
Bencin	Petrol	O	✓	O	✓	✓
Benzol	Benzen	-	✓	-	✓	✓
Trikloretilen	Trichloretylene	-	✓	-	O	✓
Toluen in ksilen	Toluene and xilene	-	✓	✓	✓	O
Petrolej	Petroleum	O	✓	O	✓	✓
Mineralna olja	Mineral oils	O	✓	O	✓	✓
Aceton	Acetone	-	O	O	✓	✓
Soliterna kislina 25-50%	Nitric acid 25-50%	-	-	✓	O	O
Kromova kislina 10%	Chrome trioxide 10%	-	-	✓	O	✓
Klorova voda	Chlorine water	✓	-	✓	O	✓
Ocetna kislina	Acetic acid	-	-	✓	✓	✓
Solna kislina	Hydrochloric acid	O	-	✓	O	✓
Žveplena kislina 25%	Sulfuric acid 25%	-	-	✓	O	✓
Lugi	Hydroxides	O	-	✓	✓	O

O vplivu ostalih kemikalij, ki niso navedene v gornji tabeli, se pred nakupom posvetujte z našo tehniško službo!

You should consult our technical service about the influence of the chemicals not cited in the above scheme.

### POVRŠINSKA ZAŠČITA

Standardna površinska zaščita kovinskih delov koles je elektro opláčenje s cinkom s transparentno pasivacijo. Odpornost na korozijo je preverjana po standardu ISO 9227: 2006 - Corrosion tests in artificial atmospheres - Salt spray tests.

Ostale možnosti površinske zaščite so še elektro opláčenje s cinkom z rumeno pasivacijo, kromanje, kataforeza (črno) in lakiranje po definiciji RAL lestvice.

### SURFACE PROTECTION

Standard coating of metal parts of castors is electro-plated coating of zinc with transparent chromate conversion. Corrosion resistance is tested according to standard ISO 9227: 2006 - Corrosion tests in artificial atmospheres - Salt spray tests.

Other options are electroplated coating of zinc with yellow iridescent chromate conversion, chromium, cathaphoresis (black) and liquid coating according RAL definition.

### VAROVANJE PRED NESNAGO

Pri uporabi koles v tekstilni industriji ali v drugih prašnih prostorih, kjer se zadržuje prah in nesnaga, priporočamo kolesa s pokrovi.

### PROTECTION AGAINST DIRT

When using the wheels at the textile industry or in other premises where dust is present, it is advisable to use the wheels with treadguards.

## BARVA KOLES

Standardne barve koles so: črna in siva za gumi obroče, zelena in rdeča za obloge koles, natur bela in črna za kolesa iz plastičnih mas. Pri večjih naročilih se prilagajamo željam kupca.

## REZERVNI DELI

Rezervni deli vseh naših standardnih koles so vedno na zalogi. Pri posebnih izvedbah koles sledi dobava rezervnih delov po dogovoru.

## VZDRŽEVANJE

Občasno preglejte vse pritrdilne elemente in jih po potrebi zatišnite. Kolesa so med sestavo oskrbljena z mazivom za življensko dobo, v kolikor so v uporabi v normalnih pogojih in temperaturnem območju **To** (stran 7). Če so kolesa izpostavljena visokim temperaturam, jih mažemo z odgovarjajočimi mastmi. Kolesa s pnevmatiko po določenem času izgubijo predpisan tlak, zato jih je potrebno ponovno napolniti.

## NAROČANJE

Pri naročanju navedite identifikacijsko (5-mestno) številko artikla, ki enoznačno definira izdelek. Posebne izvedbe koles po želji kupca se definira z opisom.

- Vse mere v katalogu so podane v mm!
- Dobave izvršujemo po prodajnih pogojih, ki so sestavni del našega cenika.
- Prepovedan je ponatis kataloga brez našega dovoljenja.
- Pridružujemo si pravico do tehniških sprememb brez predhodnega obvestila!
- S tem katalogom koles postanejo vse prejšnje izdaje neveljavne.

## COLOUR OF WHEELS

Standard colours of wheels are: black and grey for tyres, green and red for treads, natural white and black for solid wheels. With larger orders, colours can be adapted in line with customer's request.

## SPARE PARTS

Spare parts for our standard wheels are always in stock. At special production of wheels the deliveries of spare parts follow as agreed.

## MAINTENANCE

A periodical control of all housing parts is required, as well as their tightening-up when necessary. Castors and wheels are for life greased when assembled if used in normal conditions and within temperature range **To** (see page 7). If the wheels are exposed to high temperatures, they are lubricated with the corresponding grease. Pneumatic wheels lose some pressure after a while so they need to be filled up again.

## ORDER

When ordering, please state identification (5-digit) number of article which uniquely defines the product. Castors and wheels for special requirements according to customer's needs must be defined by alphabetic description.

- All the dimensions are in mm!
- We make deliveries in line with the sales conditions, which are a constituent part of our price list.
- Reprinting this catalog is not allowed without our consent.
- We reserve the right to make any technical change without prior notice.
- Upon the publication of this catalog, all previous editions become invalid.

## ZNAKI

## SYMBOLS

### Kolesa brez vilic / Wheels



### Kolesa z gibljivimi vilicami / Swivel Castors

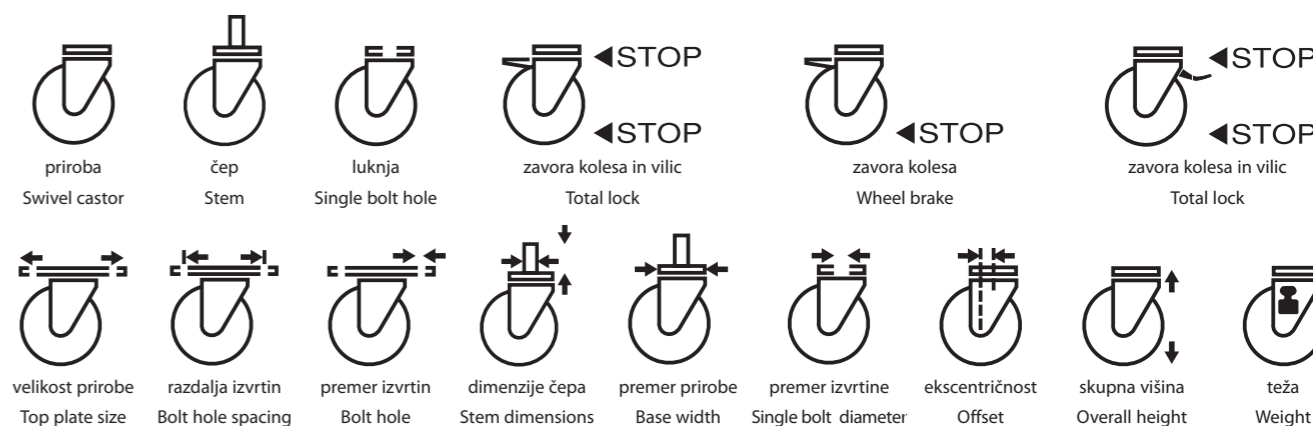

### Kolesa s stabilnimi vilicami / Fixed Castors

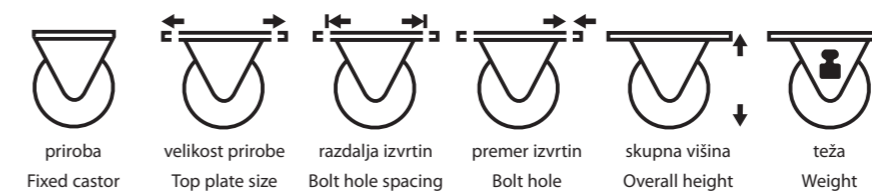

### Kolesa za pohištvo / Castors and Wheels for Furniture



### Ležaji in nosilnost / Bearings and load capacity





**KOLESA  
ZA SPLOŠNE  
NAMENE**



**CASTORS AND  
WHEELS FOR  
STANDARD USE**





## KOLESA

CINKANO JEKLENO PLATIŠČE, GUMI OBROČ, KROGLIČNI, VALJČNI ALI DRSNI LEŽAJ.

## WHEELS

ZINC ELECTRO-PLATED STEEL WHEEL CENTRE, RUBBER TYRE, BALL BEARING, ROLLER BEARING OR PLAIN BEARING.

## KOLESA Z GIBLJIVIMI VILICAMI

CINKANE JEKLENE VILICE IN PLATIŠČE, GUMI OBROČ, KROGLIČNI, VALJČNI ALI DRSNI LEŽAJ.

## SWIVEL CASTORS

ZINC ELECTRO-PLATED STEEL FORKS AND WHEEL CENTRE, RUBBER TYRE, BALL BEARING, ROLLER BEARING OR PLAIN BEARING.

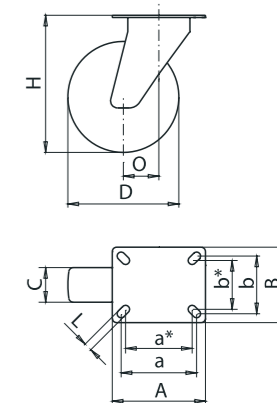

ident.	D mm	C mm		F mm	W mm	kg	kg	ident.	ident.	D mm	C mm		AxB mm	a/a*xb/b* mm	L mm	O mm	H mm	kg	kg
59303	80	30		12	44	0,25	65	59317	30293	80	30		105x85	85/75x65/55	9	40	106	0,90	65
62371	80	30		12	44	0,25	65	62389	30294	80	30		105x85	85/75x65/55	9	40	106	0,90	65
59308	100	32		12	44	0,35	80	31584	30295	100	32		105x85	85/75x65/55	9	40	128	1,00	80
62372	100	32		12	44	0,35	80	31585	30303	100	32		105x85	85/75x65/55	9	40	128	1,00	80
59309	125	37		15	44	0,60	100	59319	30304	125	37		105x85	85/75x65/55	9	40	155	1,30	100
61776	125	37		15	44	0,60	100	62391	30305	125	37		105x85	85/75x65/55	9	40	155	1,30	100
54154	150	40		20	58	0,95	170	55356	30314	150	40		135x110	110/100x85/75	11	50	180	1,85	170
61876	150	40		20	58	0,95	170	62392	30323	150	40		135x110	110/100x85/75	11	50	180	1,85	170
64154	160	40		20	58	1,05	180	64156	30324	160	40		135x110	110/100x85/75	11	50	190	2,35	180
64155	160	40		20	58	0,90	180	64391	30325	160	40		135x110	110/100x85/75	11	50	190	2,35	180
68970	180	50		20	58	1,70	200	54853	30334	180	50		135x110	110/100x85/75	11	55	210	3,30	200
68971	180	50		20	58	1,70	200	68973	30335	180	50		135x110	110/100x85/75	11	55	210	3,30	200
33494	200	50		15	58	2,10	250	56996	30343	200	50		135x110	110/100x85/75	11	60	232	3,90	250
59314	200	50		20	58	2,10	250	62393	30345	200	50		135x110	110/100x85/75	11	60	232	3,90	250
61824	200	50		20	58	2,10	250	56499		225	50		175x140	135/145x100/110	11	65	258	4,70	250
44002	225	50		15	58	2,70	250	55393		225	50		175x140	135/145x100/110	11	65	258	4,70	250
44003	225	50		20	58	2,70	250	91409		225	50		175x140	135/145x100/110	11	65	258	4,70	250
43969	225	50		20	58	2,70	250	67991		250	65		175x140	135/145x100/110	11	70	283	5,70	300
53555	250	65		20	61	3,95	300	62952		250	65		175x140	135/145x100/110	11	70	283	5,70	300
62955	250	65		25	61	3,80	300												

### RAZLIČICE - DODATKI / VARIETIES - ACCESSORIES



Gumi obroč: siva barva (za kolesa Ø80 - Ø200)

Rubber tyre: grey (for wheels Ø80 - Ø200)

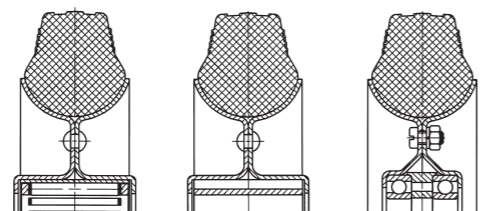

Gumi obroč / Rubber tyre



### RAZLIČICE - DODATKI / VARIETIES - ACCESSORIES



Kovinski pokrov: kataforeza - črna  
Gumi obroč: siva barva (za kolesa Ø80 - Ø200)

Metal treadguard: cataphoresis - black  
Rubber tyre: grey (for castors Ø80 - Ø200)

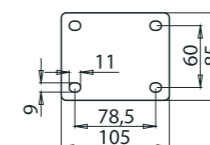

Priroba DIN: za kolesa Ø80 - Ø125  
DIN top plate: for castors Ø80 - Ø125

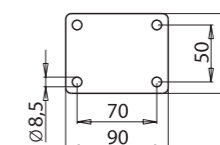

Priroba: za kolesa Ø100, Ø125  
Top plate: for castors Ø100, Ø125

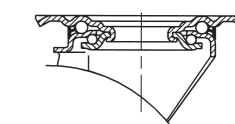

Gumi obroč / Rubber tyre





## KOLESA Z GIBLJIVIMI VILICAMI - PRITRDILNA LUKNJA

CINKANE JEKLENE VILICE IN PLATIŠČE, GUMI OBROČ, VALJČNI ALI DRSNI LEŽAJ.

### SWIVEL CASTORS - SINGLE BOLT HOUSING

ZINC ELECTRO-PLATED STEEL FORKS AND WHEEL CENTRE, RUBBER TYRE, BALL BEARING, ROLLER BEARING OR PLAIN BEARING.

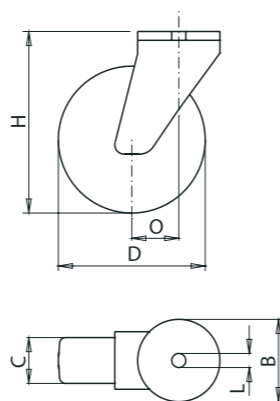

## KOLESA S STABILNIMI VILICAMI

CINKANE JEKLENE VILICE IN PLATIŠČE, GUMI OBROČ, KROGLIČNI, VALJČNI ALI DRSNI LEŽAJ.

### FIXED CASTORS

ZINC ELECTRO-PLATED STEEL FORKS AND WHEEL CENTRE, RUBBER TYRE, BALL BEARING, ROLLER BEARING OR PLAIN BEARING.

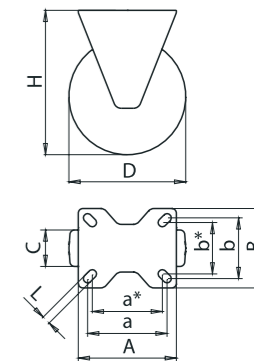

ident.	ident.	D mm	C mm		L mm	B mm	O mm	H mm	kg	kg	ident.	D mm	C mm		AxB mm	a/a*xb/b* mm	L mm	H mm	kg	kg
34005	34064	80	30	≡	12,5	70	40	106	0,90	65	59320	80	30	≡	105x85	85/75x65/55	9	106	0,60	65
34013	34065	80	30	≡	12,5	70	40	106	0,90	65	62399	80	30	≡	105x85	85/75x65/55	9	106	0,60	65
34014	34073	100	32	≡	12,5	70	40	128	1,00	80	31613	100	32	≡	105x85	85/75x65/55	9	128	0,75	80
34015	34074	100	32	≡	12,5	70	40	128	1,00	80	31633	100	32	≡	105x85	85/75x65/55	9	128	0,75	80
34023	34075	125	37	≡	12,5	70	40	155	1,30	100	59322	125	37	≡	105x85	85/75x65/55	9	155	1,10	100
34024	34083	125	37	≡	12,5	70	40	155	1,30	100	62401	125	37	≡	105x85	85/75x65/55	9	155	1,10	100
34025	34084	150	40	≡	12,5	93	50/57	180	1,85	170	55359	150	40	≡	135x110	110/100x85/75	11	180	1,75	170
34033	34085	150	40	≡	12,5	93	50/57	180	1,85	170	62402	150	40	≡	135x110	110/100x85/75	11	180	1,75	170
34034	34093	160	40	≡	12,5	93	50/57	190	2,35	180	64157	160	40	≡	135x110	110/100x85/75	11	190	1,95	180
34035	34094	160	40	≡	12,5	93	50/57	190	2,35	180	61517	160	40	≡	135x110	110/100x85/75	11	190	1,95	180
34043	34095	180	50	≡	12,5	93	50/57	210	3,30	200	55720	180	50	≡	135x110	110/100x85/75	11	210	2,70	200
34044	34103	180	50	≡	12,5	93	50/57	210	3,30	200	68978	180	50	≡	135x110	110/100x85/75	11	210	2,70	200
34045	34114	200	50	≡	12,5	93	60/55	232	3,90	250	55369	200	50	≡	135x110	110/100x85/75	11	232	3,45	250
34055	34115	200	50	≡	12,5	93	60/55	232	3,90	250	62403	200	50	≡	135x110	110/100x85/75	11	232	3,45	250
											56500	225	50	≡	175x140	135/145x100/110	11	258	4,10	250
											55375	225	50	≡	175x140	135/145x100/110	11	258	4,10	250
											22793	225	50	≡	175x140	135/145x100/110	11	258	4,10	250
											67992	250	65	≡	175x140	135/145x100/110	11	283	5,10	300
											62953	250	65	≡	175x140	135/145x100/110	11	283	5,10	300

#### RAZLIČICE - DODATKI / VARIETIES - ACCESSORIES



**Pritrdilna luknja:** po dogovoru  
**Kovinski pokrov:** kataforeza - črna  
**Gumi obroč:** siva barva

**Pritrdilni čep:** po dogovoru  
**Stem housing:** upon request

**Single bolt housing:** upon request  
**Metal treadguard:** cataphoresis - black  
**Rubber tyre:** grey

Za doseganje max. nosilnosti, mora biti podprta celotna površina prirobnice.  
To reach max. load capacity the total surface of the plate must be supported.

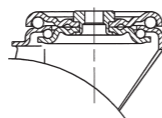

**Gumi obroč / Rubber tyre**



#### RAZLIČICE - DODATKI / VARIETIES - ACCESSORIES



**Kovinski pokrov:** kataforeza - črna  
**Gumi obroč:** siva barva

**Metal treadguard:** cataphoresis - black  
**Rubber tyre:** grey

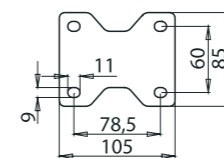

**Priroba DIN:** za kolesa Ø80 - Ø125

**DIN top plate:** for castors Ø80 - Ø125

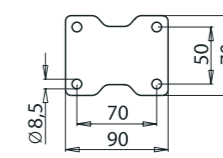

**Priroba:** za kolesa Ø100, Ø125

**Top plate:** for castors Ø100, Ø125

**Gumi obroč / Rubber tyre**





### KOLESA

PLATIŠČE IZ POLIPROPILENA, GUMI OBROČ, VALJČNI ALI DRSNI LEŽAJ.

### WHEELS

POLYPROPYLENE WHEEL CENTRE, RUBBER TYRE, ROLLER BEARING OR PLAIN BEARING.



### KOLESA Z GIBLJIVIMI VILICAMI

CINKANE JEKLENE VILICE, PLATIŠČE IZ POLIPROPILENA, GUMI OBROČ, VALJČNI ALI DRSNI LEŽAJ.

### SWIVEL CASTORS

ZINC ELECTRO-PLATED STEEL FORKS, POLYPROPYLENE WHEEL CENTRE, RUBBER TYRE, ROLLER BEARING OR PLAIN BEARING.

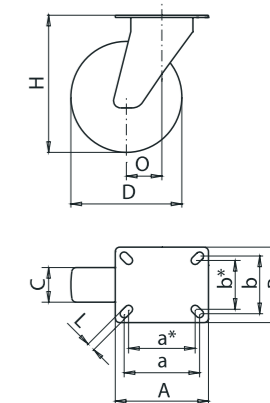

črna guma black tyre		siva guma grey tyre		D mm		C mm		F mm		W mm		kg		kg		črna guma black tyre		siva guma grey tyre		črna guma black tyre		siva guma grey tyre		D mm		C mm		AxB mm		a/a*xb/b* mm		L mm		O mm		H mm		kg		kg		
ident.	ident.	ident.	ident.	ident.	ident.	ident.	ident.	ident.	ident.	ident.	ident.	ident.	ident.	ident.	ident.	ident.	ident.	ident.	ident.	ident.	ident.	ident.	ident.	ident.	ident.	ident.	ident.	ident.	ident.	ident.	ident.	ident.	ident.	ident.	ident.	ident.	ident.	ident.	ident.	ident.	ident.	ident.
30193	39355	80	30	12	44	0,20	65	31105	39384	31193	39415	80	30	105x85	85/75x65/55	9	40	106	0,85	65																						
30205	38863	80	30	12	44	0,15	65	31113	39385	31194	39423	80	30	105x85	85/75x65/55	9	40	106	0,80	65																						
30214	33554	100	32	12	44	0,25	80	31114	33555	31195	38613	100	32	105x85	85/75x65/55	9	40	128	0,95	80																						
30215	39363	100	32	12	44	0,20	80	31115	39393	31203	39424	100	32	105x85	85/75x65/55	9	40	128	0,90	80																						
30223	43523	125	36	15	44	0,45	100	31123	33353	31204	39425	125	37	105x85	85/75x65/55	9	40	155	1,15	100																						
30225	36344	125	36	15	44	0,40	100	31124	39244	31205	39245	125	37	105x85	85/75x65/55	9	40	155	1,10	100																						
30245	39364	150	40	20	58	0,65	170	31133	39394	31213	39433	150	40	135x110	110/100x85/75	11	50/57	180	1,55	170																						
30253	39365	150	40	20	58	0,60	170	31134	39395	31214	39434	150	40	135x110	110/100x85/75	11	50/57	180	1,50	170																						
30255	38603	160	40	20	58	0,75	180	31135	38683	31215	39435	160	40	135x110	110/100x85/75	11	50/57	190	2,05	180																						
91052	39373	160	40	20	58	0,70	180	91836	39403	31223	39443	160	40	135x110	110/100x85/75	11	50/57	190	1,95	180																						
30264	39374	180	50	20	58	1,20	200	31144	39404	31224	39444	180	50	135x110	110/100x85/75	11	50/57	210	2,80	200																						
30265	39375	180	50	20	58	1,15	200	31145	39405	31225	39445	180	50	135x110	110/100x85/75	11	50/57	210	2,70	200																						
30273	35463	200	50	20	58	1,45	250	31165	39413	31233	35453	200	50	135x110	110/100x85/75	11	60/55	232	3,25	250																						
91054	39383	200	50	20	58	1,40	250	64069	39414	31234	39453	200	50	135x110	110/100x85/75	11	60/55	232	3,15	250																						
47078		250	60	25	77	2,60	300																																			

### RAZLIČICE - DODATKI / VARIETIES - ACCESSORIES



Platišče: barva po dogovoru  
Wheel centre: color upon request

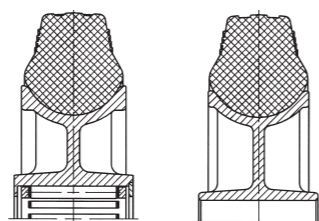

Gumi obroč / Rubber tyre  
80 ShA  
83 ShA

### RAZLIČICE - DODATKI / VARIETIES - ACCESSORIES



Platišče: barva po dogovoru  
Kovinski pokrov: cinkan, kataforeza - črna  
Wheel centre: color upon request  
Metal treadguard: zinc electro-plated, cathaphoresis - black

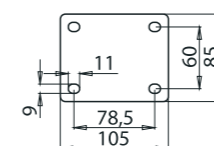

Priroba DIN: za kolesa Ø80 - Ø125  
DIN top plate: for castors Ø80 - Ø125

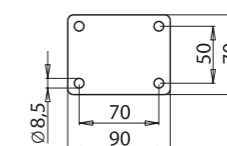

Priroba: za kolesa Ø100, Ø125  
Top plate: for castors Ø100, Ø125

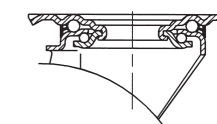

Gumi obroč / Rubber tyre  
80 ShA  
83 ShA





## KOLESA Z GIBLJIVIMI VILICAMI - PRITRDILNA LUKNJA

CINKANE JEKLENE VILICE, PLATIŠČE IZ POLIPROPILENA, GUMI OBROČ, VALJČNI ALI DRSNI LEŽAJ.

### SWIVEL CASTORS - SINGLE BOLT HOUSING

ZINC ELECTRO-PLATED STEEL FORKS, POLYPROPYLENE WHEEL CENTRE, RUBBER TYRE, ROLLER BEARING OR PLAIN BEARING.

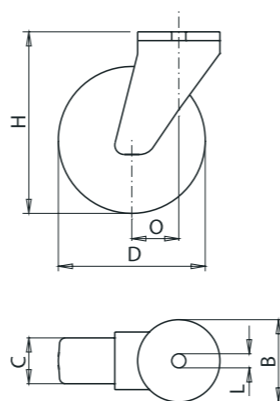

## KOLESA S STABILNIMI VILICAMI

CINKANE JEKLENE VILICE, PLATIŠČE IZ POLIPROPILENA, GUMI OBROČ, VALJČNI ALI DRSNI LEŽAJ.

### FIXED CASORS

ZINC ELECTRO-PLATED STEEL FORKS, POLYPROPYLENE WHEEL CENTRE, RUBBER TYRE, ROLLER BEARING OR PLAIN BEARING.

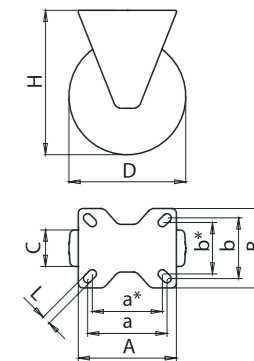
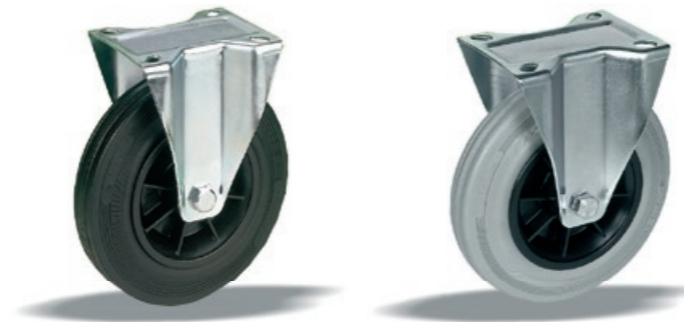

črna guma black tyre	siva guma grey tyre	črna guma black tyre	črna guma black tyre	črna guma black tyre	črna guma black tyre	črna guma black tyre	črna guma black tyre	črna guma black tyre	črna guma black tyre	črna guma black tyre	črna guma black tyre	črna guma black tyre	črna guma black tyre
ident.	ident.	ident.	ident.	D mm	C mm	L mm	B mm	O mm	H mm	kg	kg	kg	kg
34123	39545	34195	39585	80	30	12,5	70	40	106	0,85	65	65	65
34125	39553	34203	39593	80	30	12,5	70	40	106	0,80	65	65	65
34134	39253	34204	39594	100	32	12,5	70	40	128	0,95	80	80	80
34135	39554	34205	39595	100	32	12,5	70	40	128	0,90	80	80	80
34143	38614	34214	38615	125	37	12,5	70	40	155	1,15	100	100	100
34145	39555	34215	39603	125	37	12,5	70	40	155	1,10	100	100	100
34153	39563	34223	39604	150	40	12,5	93	50/57	180	1,55	170	170	170
34154	39564	34224	39605	150	40	12,5	93	50/57	180	1,50	170	170	170
34155	38583	34225	39613	160	40	12,5	93	50/57	190	2,05	180	180	180
34163	39565	34233	39614	160	40	12,5	93	50/57	190	1,95	180	180	180
34183	39573	34234	39615	180	50	12,5	93	55/55	210	2,80	200	200	200
34184	39574	34243	39623	180	50	12,5	93	55/55	210	2,70	200	200	200
34185	39575	34244	39624	200	50	12,5	93	60/55	232	3,25	250	250	250
34193	39583	34245	39625	200	50	12,5	93	60/55	232	3,15	250	250	250

črna guma black tyre	siva guma grey tyre	črna guma black tyre	črna guma black tyre	črna guma black tyre	črna guma black tyre	črna guma black tyre	črna guma black tyre	črna guma black tyre	črna guma black tyre	črna guma black tyre	črna guma black tyre	črna guma black tyre	črna guma black tyre
ident.	ident.	D mm	C mm	AxB mm	a/a*xb/b* mm	L mm	H mm	kg	kg	kg	kg	kg	kg
31473	39633	80	30	105x85	85/75x65/55	9	106	0,55	65	65	65	65	65
31474	39634	80	30	105x85	85/75x65/55	9	106	0,50	65	65	65	65	65
31475	38605	100	32	105x85	85/75x65/55	9	128	0,65	80	80	80	80	80
31483	39635	100	32	105x85	85/75x65/55	9	128	0,60	80	80	80	80	80
31484	33383	125	37	105x85	85/75x65/55	9	155	0,85	100	100	100	100	100
31485	39643	125	37	105x85	85/75x65/55	9	155	0,80	100	100	100	100	100
31493	39644	150	40	135x110	110/100x85/75	11	180	1,45	170	170	170	170	170
31494	39645	150	40	135x110	110/100x85/75	11	180	1,40	170	170	170	170	170
31495	38584	160	40	135x110	110/100x85/75	11	190	1,65	180	180	180	180	180
91787	39653	160	40	135x110	110/100x85/75	11	190	1,60	180	180	180	180	180
31515	39654	180	50	135x110	110/100x85/75	11	210	2,20	200	200	200	200	200
31523	39655	180	50	135x110	110/100x85/75	11	210	2,15	200	200	200	200	200
31524	35455	200	50	135x110	110/100x85/75	11	232	2,80	250	250	250	250	250
64070	39663	200	50	135x110	110/100x85/75	11	232	2,75	250	250	250	250	250

### RAZLIČICE - DODATKI / VARIETIES - ACCESSORIES



**Pritrdilna luknja:** po dogovoru  
**Platišče:** barva po dogovoru  
**Kovinski pokrov:** cinkan, kataforeza - črna

**Single bolt housing:** upon request  
**Wheel centre:** color upon request  
**Metal treadguard:** zinc electro-plated, cathoresis - black

**Pritrdilni čep:** po dogovoru  
**Stem housing:** upon request

Za doseganje max. nosilnosti, mora biti podprta celotna površina prirobnice.  
 To reach max. load capacity the total surface of the plate must be supported.

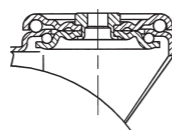

**Gumi obroč / Rubber tyre**

80 ShA      83 ShA

### RAZLIČICE - DODATKI / VARIETIES - ACCESSORIES

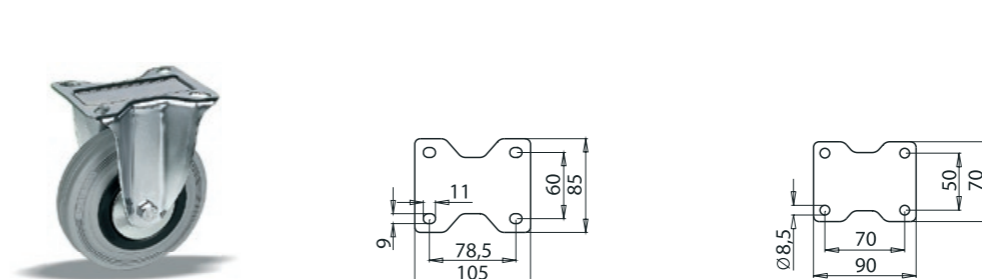

**Platišče:** barva po dogovoru  
**Kovinski pokrov:** cinkan, kataforeza - črna

**Wheel centre:** color upon request  
**Metal treadguard:** zinc electro-plated, cathoresis - black

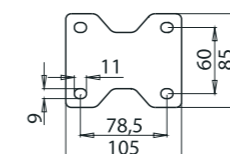

**Priroba DIN:** za kolesa Ø80 - Ø125  
**DIN top plate:** for castors Ø80 - Ø125

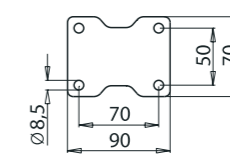

**Priroba:** za kolesa Ø100, Ø125  
**Top plate:** for castors Ø100, Ø125

**Gumi obroč / Rubber tyre**

80 ShA      83 ShA



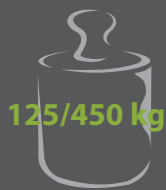

## KOLESA

KOLO IZ POLIPROPILENA (PP) ALI POLIAMIDA (PA), ČRNE ALI NATUR BELE BARVE, KROGLIČNI, VALJČNI ALI DRSNI LEŽAJ.

## WHEELS

POLYPROPYLENE (PP) OR POLYAMIDE (PA) SOLID WHEEL, BLACK OR NATURAL WHITE COLOUR, BALL BEARING, ROLLER BEARING OR PLAIN BEARING.



## KOLESA Z GIBLJIVIMI VILICAMI

CINKANE JEKLENE VILICE, KOLO IZ POLIPROPILENA (PP) ALI POLIAMIDA (PA), ČRNE ALI NATUR BELE BARVE, KROGLIČNI, VALJČNI ALI DRSNI LEŽAJ.

## SWIVEL CASTORS

ZINC ELECTRO-PLATED STEEL FORKS, POLYPROPYLENE (PP) OR POLYAMIDE (PA) SOLID WHEEL, BLACK OR NATURAL WHITE COLOUR, BALL BEARING, ROLLER BEARING, OR PLAIN BEARING.

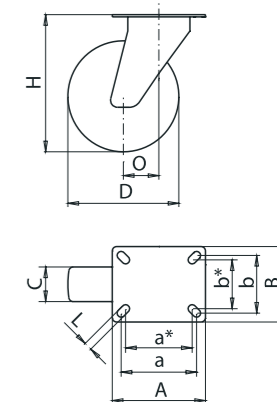

ident.	ident.	ident.	ident.	D mm	C mm		F mm	W mm	kg	kg	kg
58469	66718	66497	66703	80	35		12	44	0,12	125	200
59215	66722	66708	66713	80	35		12	44	0,08	125	200
42763	42755	42754	42753	100	35		12	44	0,26	160	250
58475	67035	66498	66704	100	35		12	44	0,14	160	200
59216	65054	66709	66714	100	35		12	44	0,10	160	250
42773	42765	42764	42744	125	38		12	44	0,31	200	300
58477	66719	66499	66705	125	38		12	44	0,18	200	250
59217	66723	66710	66715	125	38		12	44	0,14	200	300
58503	66720	66701	66706	150	46		20	58	0,45	250	350
59218	66724	66711	66716	150	46		20	58	0,35	300	400
58508	66721	66702	66707	200	50		20	58	0,70	250	350
59219	66725	66712	66717	200	50		20	58	0,60	300	400
* 42644	* 42643	* 42635	* 42463	100	35		8,5	44	0,17	125	200
* 42784	* 42783	* 42774	* 42775	125	38		8,5	44	0,22	200	250
			** 43435	125	38		12	44	0,32		350
			*** 43443	125	38		12	44	0,33		400
		**** 91631	**** 91355	150	40		20	50	0,31		350
		**** 30183	**** 32884	200	40		20	50	0,51		450

ident.	ident.	ident.	ident.	D mm	C mm	AxB mm	a/a*xb/b* mm	L mm	O mm	H mm	kg	kg	
60800	66736	30515	30593	80	35		105x85	85/75x65/55	9	40	106	0,63	125
60808	66852	30525	30594	80	35		105x85	85/75x65/55	9	40	106	0,59	125
44021	44022	44029	44030	100	35		105x85	85/75x65/55	9	40	128	0,68	160
32385	32393	30533	30595	100	35		105x85	85/75x65/55	9	40	128	0,65	160
31645	31644	30535	30645	100	35		105x85	85/75x65/55	9	40	128	0,61	160
44025	44026	44033	44034	125	38		105x85	85/75x65/55	9	40	155	0,74	200
60801	66738	30543	30655	125	38		105x85	85/75x65/55	9	40	155	0,70	200
60810	66854	30563	30663	125	38		105x85	85/75x65/55	9	40	155	0,66	200
60802	66739	30564	30664	150	46		135x110	110/100x85/75	11	50	180	1,70	250
60811	66855	30565	30673	150	46		135x110	110/100x85/75	11	50	180	1,60	300
60803	66740	30573	30675	200	50		135x110	110/100x85/75	11	60	232	2,10	250
60812	66856	30574	30683	200	50		135x110	110/100x85/75	11	60	232	2,00	300
66728	66733	30435	30484	80	35		105x85	85/75x65/55	9	40	106	0,63	200
66842	66847	30443	30485	80	35		105x85	85/75x65/55	9	40	106	0,59	200
44023	44024	44031	44032	100	35		105x85	85/75x65/55	9	40	128	0,68	250
32383	32384	30444	30493	100	35		105x85	85/75x65/55	9	40	128	0,65	200
31635	31634	30445	30494	100	35		105x85	85/75x65/55	9	40	128	0,61	250
44027	44028	44035	44036	125	38		105x85	85/75x65/55	9	40	155	0,74	300
66730	67161	30463	30495	125	38		105x85	85/75x65/55	9	40	155	0,70	250
66844	66849	30464	30503	125	38		105x85	85/75x65/55	9	40	155	0,66	300
66731	66734	30465	30504	150	46		135x110	110/100x85/75	11	50	180	1,70	350
66845	66850	30474	30505	150	46		135x110	110/100x85/75	11	50	180	1,60	400
66732	66735	30475	30513	200	50		135x110	110/100x85/75	11	60	232	2,10	350
66846	66851	30483	30514	200	50		135x110	110/100x85/75	11	60	232	2,00	400

### RAZLIČICE - DODATKI / VARIETIES - ACCESSORIES

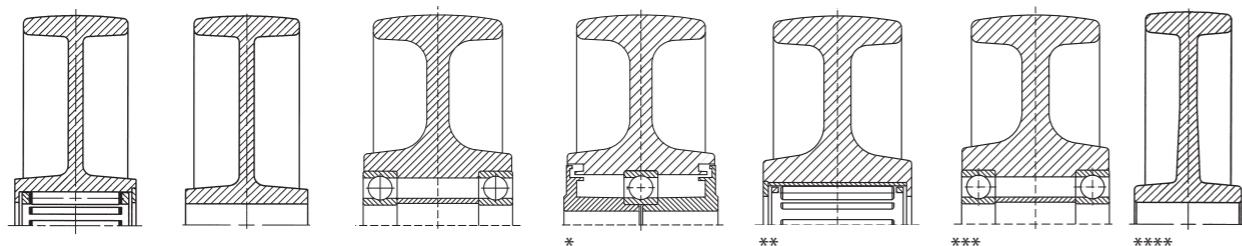

### RAZLIČICE - DODATKI / VARIETIES - ACCESSORIES

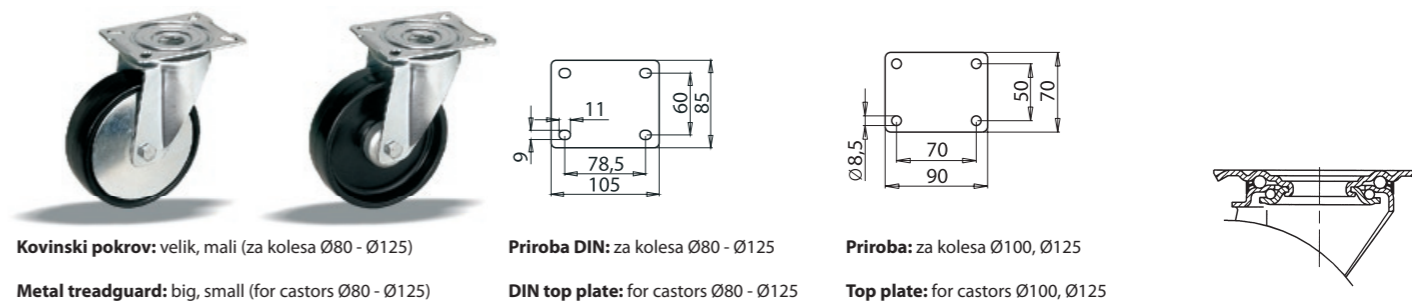

Kovinski pokrov: velik, mali (za kolesa Ø80 - Ø125)  
Metal treadguard: big, small (for castors Ø80 - Ø125)

Priroba DIN: za kolesa Ø80 - Ø125  
DIN top plate: for castors Ø80 - Ø125

Priroba: za kolesa Ø100, Ø125  
Top plate: for castors Ø100, Ø125



## KOLESA Z GIBLJIVIMI VILICAMI - PRITRDILNA LUKNJA

CINKANE JEKLENE VILICE, KOLO IZ POLIPROPILENA (PP) ALI POLIAMIDA (PA), ČRNE ALI NATUR BARVE, KROGLIČNI, VALJČNI ALI DRSNI LEŽAJ.

### SWIVEL CASTORS - SINGLE BOLT HOUSING

ZINC ELECTRO-PLATED STEEL FORKS, POLYPROPYLENE (PP) OR POLYAMIDE (PA) SOLID WHEEL, BLACK OR NATURAL WHITE COLOUR, BALL BEARING, ROLLER BEARING OR PLAIN BEARING.

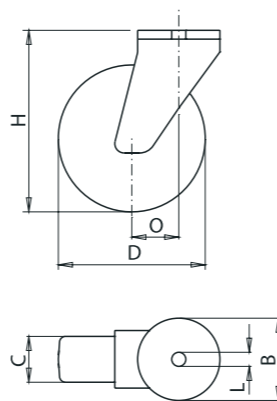

## KOLESA S STABILNIMI VILICAMI

CINKANE JEKLENE VILICE, KOLO IZ POLIPROPILENA (PP) ALI POLIAMIDA (PA), ČRNE ALI NATUR BELE BARVE, KROGLIČNI, VALJČNI ALI DRSNI LEŽAJ.

### FIXED CASTORS

ZINC ELECTRO-PLATED STEEL FORKS, POLYPROPYLENE (PP) OR POLYAMIDE (PA) SOLID WHEEL, BLACK OR NATURAL WHITE COLOUR, BALL BEARING, ROLLER BEARING OR PLAIN BEARING.

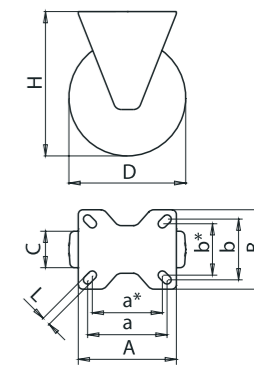

PP - črn PP - black	PP - bel PP - white	PP - črn PP - black	PP - bel PP - white	D mm	C mm		L mm	B mm	O mm	H mm	kg	kg
34253	34323	34504	34583	80	35	≡	12,5	70	40	106	0,63	125
34255	34333	34514	34584	80	35	≡	12,5	70	40	106	0,59	125
44037	44038	44045	44046	100	35	≡	12,5	70	40	128	0,68	160
34273	34334	34515	34585	100	35	≡	12,5	70	40	128	0,65	160
34274	34335	34525	34593	100	35	≡	12,5	70	40	128	0,61	160
44041	44042	44049	44050	125	38	≡	12,5	70	40	155	0,74	200
34283	34343	34544	34594	125	38	≡	12,5	70	40	155	0,70	200
34285	34344	34545	34595	125	38	≡	12,5	70	40	155	0,66	200
34293	34345	34553	34603	150	46	≡	12,5	93	50	180	1,70	250
34295	34354	34554	34604	150	46	≡	12,5	93	50	180	1,60	300
34303	34355	34573	34605	200	50	≡	12,5	93	60	232	2,10	250
34305	34373	34574	34623	200	50	≡	12,5	93	60	232	2,00	300

PA - črn PA - black	PA - bel PA - white	PA - črn PA - black	PA - bel PA - white	D mm	C mm		L mm	B mm	O mm	H mm	kg	kg
34375	34453	34624	34703	80	35	≡	12,5	70	40	106	0,63	200
34383	34455	34625	34704	80	35	≡	12,5	70	40	106	0,59	200
44039	44040	44047	44048	100	35	≡	12,5	70	40	128	0,68	250
34384	34463	34633	34715	100	35	≡	12,5	70	40	128	0,65	200
34385	34464	34634	34723	100	35	≡	12,5	70	40	128	0,61	250
44043	44044	44051	44052	125	38	≡	12,5	70	40	155	0,74	250
34393	34473	34635	34725	125	38	≡	12,5	70	40	155	0,70	250
34414	34474	34645	34733	125	38	≡	12,5	70	40	155	0,66	250
34415	34475	34665	34734	150	46	≡	12,5	93	50	180	1,70	350
34423	34483	34684	34735	150	46	≡	12,5	93	50	180	1,60	400
34434	34485	34693	34743	200	50	≡	12,5	93	60	232	2,10	350
34443	34503	34694	34744	200	50	≡	12,5	93	60	232	2,00	400

PP - črn PP - black	PP - bel PP - white	PA - črn PA - black	PA - bel PA - white	D mm	C mm		AxB mm	a/a*xb/b* mm	L mm	H mm	kg	kg	kg
60804	67004	66993	66998	80	35	≡	105x85	85/75x65/55	9	106	0,53	125	200
60813	67019	67009	67014	80	35	≡	105x85	85/75x65/55	9	106	0,49	125	200
44053	44054	44055	44056	100	35	≡	105x85	85/75x65/55	9	128	0,58	160	250
32484	32485	32475	32483	100	35	≡	105x85	85/75x65/55	9	128	0,55	160	200
31705	31704	31703	31695	100	35	≡	105x85	85/75x65/55	9	128	0,51	160	250
44057	44058	44059	44060	125	38	≡	105x85	85/75x65/55	9	155	0,66	200	300
60805	67006	66995	67001	125	38	≡	105x85	85/75x65/55	9	155	0,62	200	250
60815	67021	67011	67016	125	38	≡	105x85	85/75x65/55	9	155	0,58	200	300
60806	67007	66996	67002	150	46	≡	135x110	110/100x85/75	11	180	1,30	250	350
60816	67022	67012	67017	150	46	≡	135x110	110/100x85/75	11	180	1,20	300	400
60807	67008	66997	67003	200	50	≡	135x110	110/100x85/75	11	232	1,65	250	350
60817	67023	67013	67018	200	50	≡	135x110	110/100x85/75	11	232	1,55	300	400

### RAZLIČICE - DODATKI / VARIETIES - ACCESSORIES



**Pritrdilna luknja:** po dogovoru  
**Kovinski pokrov:** velik, mali (za kolesa Ø80 - Ø125)  
**Single bolt housing:** upon request  
**Metal treadguard:** big, small (for castors Ø80 - Ø125)

Za doseganje max. nosilnosti, mora biti podprta celotna površina prirobnice.  
 To reach max. load capacity the total surface of the plate must be supported.

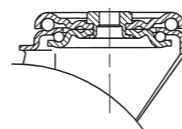

### RAZLIČICE - DODATKI / VARIETIES - ACCESSORIES



**Kovinski pokrov:** velik, mali (za kolesa Ø80 - Ø125)  
**Metal treadguard:** big, small (for castors Ø80 - Ø125)

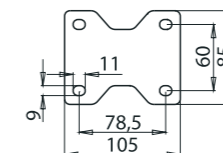

**Priroba DIN:** za kolesa Ø80 - Ø125  
**DIN top plate:** for castors Ø80 - Ø125

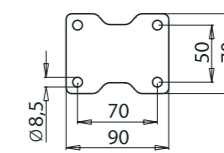

**Priroba:** za kolesa Ø100, Ø125  
**Top plate:** for castors Ø100, Ø125



## KOLESA

PLATIŠČE IZ POLIAMIDA, POLIURETANSKA OBLOGA (92 ShA), KROGLIČNI, VALJČNI ALI DRSNI LEŽAJ.

## WHEELS

POLYAMIDE WHEEL CENTRE, POLYURETHANE TREAD (92 ShA), BALL BEARING, ROLLER BEARING OR PLAIN BEARING.

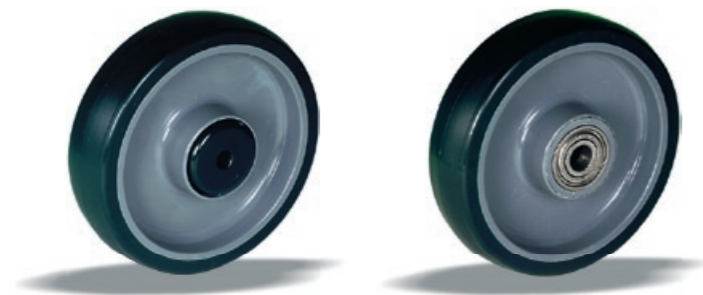

## KOLESA Z GIBLJIVIMI VILICAMI

CINKANE JEKLENE VILICE, PLATIŠČE IZ POLIAMIDA, POLIURETAN OBLOGA (92 ShA), KROGLIČNI, VALJČNI ALI DRSNI LEŽAJ.

## SWIVEL CASTORS

ZINC ELECTRO-PLATED STEEL FORKS, POLYAMIDE WHEEL CENTRE, POLYURETHANE TREAD (92 ShA), BALL BEARING, ROLLER BEARING OR PLAIN BEARING.

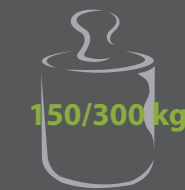
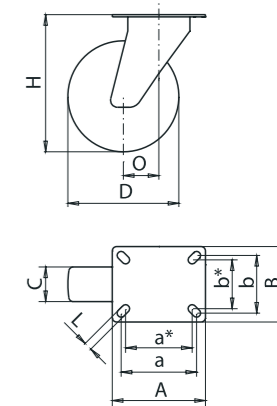

Ident.	D mm	C mm	F mm	W mm	kg	kg	ident.	ident.	D mm	C mm	AxB mm	a/a*xb/b* mm	L mm	O mm	H mm	kg	kg
40423	100	32	12	44	0,30	150	40503	40543	100	32	105x85	85/75x65/55	9	40	128	0,92	150
40415	100	32	8,5	44	0,27	150	40495	40535	100	32	105x85	85/75x65/55	9	40	128	0,87	150
40414	100	32	8,5	44	0,23	150	40494	40534	100	32	105x85	85/75x65/55	9	40	128	0,83	150
40433	125	32	12	44	0,37	200	40513	40553	125	32	105x85	85/75x65/55	9	40	155	1,04	200
40425	125	32	8,5	44	0,34	200	40505	40545	125	32	105x85	85/75x65/55	9	40	155	0,99	200
40424	125	32	8,5	44	0,30	200	40504	40544	125	32	105x85	85/75x65/55	9	40	155	0,95	200
40443	160	50	20	58	0,65	400	40523	40563	160	50	135x110	110/100x85/75	11	50/57	190	1,73	300
40435	160	50	12,5	58	0,60	400	40515	40555	160	50	135x110	110/100x85/75	11	50/57	190	1,64	300
40434	160	50	12,5	58	0,50	400	40514	40554	160	50	135x110	110/100x85/75	11	50/57	190	1,58	300
40453	200	50	20	58	1,10	500	40533	40573	200	50	135x110	110/100x85/75	11	60/55	232	3,33	300
40445	200	50	12,5	58	1,00	500	40525	40565	200	50	135x110	110/100x85/75	11	60/55	232	3,17	300
40444	200	50	12,5	58	0,95	500	40524	40564	200	50	135x110	110/100x85/75	11	60/55	232	3,04	300

### RAZLIČICE - DODATKI / VARIETIES - ACCESSORIES

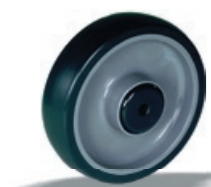

Platišče: barva po dogovoru  
Plastični pokrov: barva po dogovoru  
Poliuretanska obloga: barva po dogovoru

Wheel centre: color upon request  
Plastic treadguard: color upon request  
Polyurethane tread: color upon request

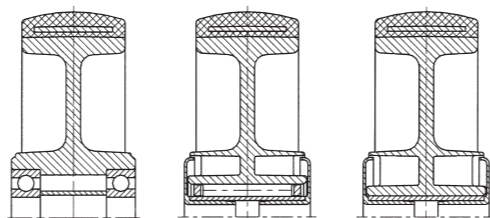

### RAZLIČICE - DODATKI / VARIETIES - ACCESSORIES



Kovinski pokrov: velik  
Platišče: barva po dogovoru  
Poliuretanska obloga: barva po dogovoru

Metal treadguard: big  
Wheel centre: color upon request  
Polyurethane tread: color upon request

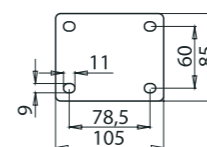

Priroba DIN: za kolesa Ø100, Ø125  
DIN top plate: for castors Ø100, Ø125

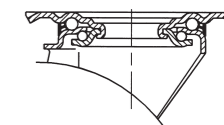





## KOLESA Z GIBLJIVIMI VILICAMI - PRITRDILNA LUKNJA

CINKANE JEKLENE VILICE, PLATIŠČE IZ POLIAMIDA, POLIURETAN OBLOGA (92 ShA), KROGLIČNI, VALJČNI ALI DRSNI LEŽAJ.

### SWIVEL CASTORS - SINGLE BOLT HOUSING

ZINC ELECTRO-PLATED STEEL FORKS, POLYAMIDE WHEEL CENTRE, POLYURETHANE TREAD (92 ShA), BALL BEARING, ROLLER BEARING OR PLAIN BEARING.

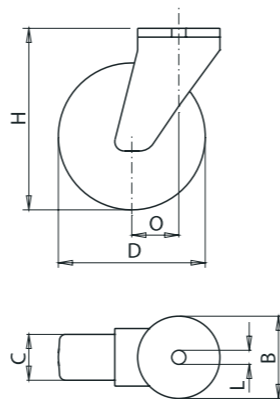

## KOLESA S STABILNIMI VILICAMI

CINKANE JEKLENE VILICE, PLATIŠČE IZ POLIAMIDA, POLIURETAN OBLOGA (92 ShA), KROGLIČNI, VALJČNI ALI DRSNI LEŽAJ.

### FIXED CASTORS

ZINC ELECTRO-PLATED STEEL FORKS, POLYAMIDE WHEEL CENTRE, POLYURETHANE TREAD (92 ShA), BALL BEARING, ROLLER BEARING OR PLAIN BEARING.

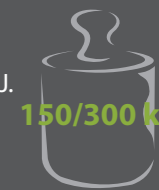
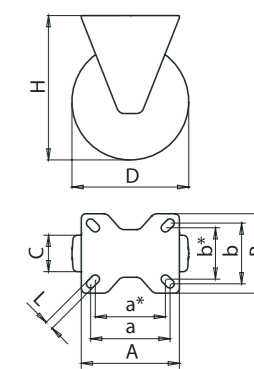

ident.	ident.	D mm	C mm		L mm	B mm	O mm	H mm	mm	kg	ident.	D mm	C mm		AxB mm	a/a*x/b/b* mm	L mm	H mm	kg	kg
40583	40623	100	32	☉	12,5	70	40	128	0,92	150	40463	100	32	☉	105x85	85/75x65/55	9	128	0,57	150
40575	40615	100	32	☉	12,5	70	40	128	0,87	150	40455	100	32	☉	105x85	85/75x65/55	9	128	0,52	150
40574	40614	100	32	☉	12,5	70	40	128	0,83	150	40454	100	32	☉	105x85	85/75x65/55	9	128	0,48	150
40593	40633	125	32	☉	12,5	70	40	155	1,04	200	40473	125	32	☉	105x85	85/75x65/55	9	155	0,60	200
40585	40625	125	32	☉	12,5	70	40	155	0,99	200	40465	125	32	☉	105x85	85/75x65/55	9	155	0,64	200
40584	40624	125	32	☉	12,5	70	40	155	0,95	200	40464	125	32	☉	105x85	85/75x65/55	9	155	0,69	200
40603	40643	160	50	☉	12,5	93	50/57	190	1,73	300	40483	160	50	☉	135x110	110/100x85/75	11	190	1,15	300
40595	40635	160	50	☉	12,5	93	50/57	190	1,64	300	40475	160	50	☉	135x110	110/100x85/75	11	190	1,10	300
40594	40634	160	50	☉	12,5	93	50/57	190	1,58	300	40474	160	50	☉	135x110	110/100x85/75	11	190	1,00	300
40613	40653	200	50	☉	12,5	93	60/55	232	3,33	300	40493	200	50	☉	135x110	110/100x85/75	11	232	2,21	300
40605	40645	200	50	☉	12,5	93	60/55	232	3,17	300	40485	200	50	☉	135x110	110/100x85/75	11	232	2,05	300
40604	40644	200	50	☉	12,5	93	60/55	232	3,04	300	40484	200	50	☉	135x110	110/100x85/75	11	232	1,92	300

### RAZLIČICE - DODATKI / VARIETIES - ACCESSORIES



**Kovinski pokrov:** velik  
**Platišče:** barva po dogovoru  
**Poliuretanska obloga:** barva po dogovoru  
**Pritrdilna luknja:** po dogovoru

**Metal treadguard:** big  
**Wheel centre:** color upon request  
**Polyurethane tread:** color upon request  
**Single bolt housing:** upon request

Za doseganje max. nosilnosti, mora biti podprta celotna površina prirobnice.  
To reach max. load capacity the total surface of the plate must be supported.

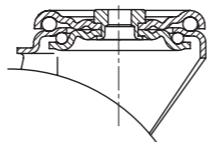

### RAZLIČICE - DODATKI / VARIETIES - ACCESSORIES



**Kovinski pokrov:** velik  
**Platišče:** barva po dogovoru  
**Poliuretanska obloga:** barva po dogovoru

**Metal treadguard:** big  
**Wheel centre:** color upon request  
**Polyurethane tread:** color upon request

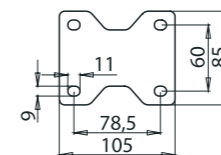

**Priroba DIN:** za kolesa Ø100, Ø125  
**DIN top plate:** for castors Ø100, Ø125



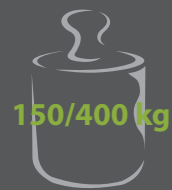

## KOLESA

PLATIŠČE IZ POLIAMIDA, NALITA GUMA-ELASTIK (70 ShA), KROGLIČNI, VALJČNI ALI DRSNI LEŽAJ.

## WHEELS

POLYAMIDE WHEEL CENTRE, NON-MARKING SOFT RUBBER TREAD (70 ShA), BALL BEARING, ROLLER BEARING OR PLAIN BEARING.



## KOLESA Z GIBLJIVIMI VILICAMI

CINKANE JEKLENE VILICE, PLATIŠČE IZ POLIPROPILENA, NALITA GUMA-ELASTIK (70 ShA), KROGLIČNI, VALJČNI ALI DRSNI LEŽAJ.

## SWIVEL CASTORS

ZINC ELECTRO-PLATED STEEL FORKS, POLYAMIDE WHEEL CENTRE, NON-MARKING SOFT RUBBER TREAD (70 ShA), BALL BEARING, ROLLER BEARING OR PLAIN BEARING.

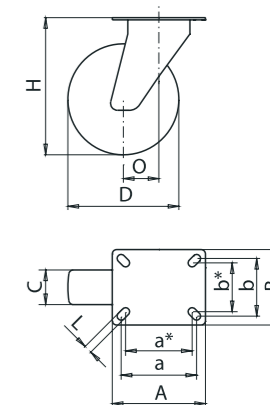

Ident.	D mm	C mm	F mm	mm	kg	kg	ident.	ident.	D mm	C mm	AxB mm	a/a*xb/b* mm	L mm	O mm	H mm	kg	kg
39845	100	35	12	44	0,30	150	39923	39963	100	35	105x85	85/75x65/55	9	40	128	0,92	150
39843	100	35	12	44	0,27	150	39915	39955	100	35	105x85	85/75x65/55	9	40	128	0,87	150
39834	100	35	15	44	0,23	150	39914	39954	100	35	105x85	85/75x65/55	9	40	128	0,83	150
39865	125	35	12	44	0,37	200	39933	39973	125	35	105x85	85/75x65/55	9	40	155	1,04	200
39863	125	35	12	44	0,34	200	39925	39965	125	35	105x85	85/75x65/55	9	40	155	0,99	200
39854	125	35	15	44	0,30	200	39924	39964	125	35	105x85	85/75x65/55	9	40	155	0,95	200
40133	160	50	20	58	0,65	350	39943	39983	160	50	135x110	110/100x85/75	11	50	190	1,73	300
40124	160	50	20	58	0,60	350	39935	39975	160	50	135x110	110/100x85/75	11	50	190	1,64	300
40115	160	50	20	58	0,50	350	39934	39974	160	50	135x110	110/100x85/75	11	50	190	1,58	300
40153	200	50	20	58	1,10	400	39953	39993	200	50	135x110	110/100x85/75	11	60	232	3,33	300
40144	200	50	20	58	1,00	400	39945	39985	200	50	135x110	110/100x85/75	11	60	232	3,17	300
40135	200	50	20	58	0,95	400	39944	39984	200	50	135x110	110/100x85/75	11	60	232	3,04	300

### RAZLIČICE - DODATKI / VARIETIES - ACCESSORIES



Platišče: barva po dogovoru  
Guma-elastik: barva po dogovoru

Wheel centre: color upon request  
Non-marking soft rubber tread: color upon request

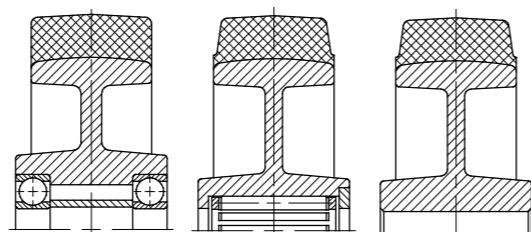

### RAZLIČICE - DODATKI / VARIETIES - ACCESSORIES



Kovinski pokrov: velik  
Platišče: barva po dogovoru  
Guma-elastik: barva po dogovoru

Metal treadguard: big  
Wheel centre: color upon request  
Non-marking soft rubber tread: color upon request

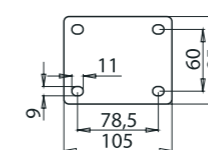

Priroba DIN: za kolesa Ø100, Ø125

DIN top plate: for castors Ø100, Ø125

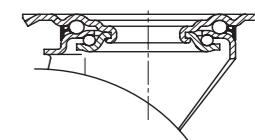



## KOLESA Z GIBLJIVIMI VILICAMI - PRITRDILNA LUKNJA

CINKANE JEKLENE VILICE, PLATIŠČE IZ POLIAMIDA, NALITA GUMA-ELASTIK (70 ShA), KROGLIČNI, VALJČNI ALI DRSNI LEŽAJ.

### SWIVEL CASTORS - SINGLE BOLT HOUSING

ZINC ELECTRO-PLATED STEEL FORKS, POLYAMIDE WHEEL CENTRE, NON-MARKING SOFT RUBBER TREAD (70 ShA), BALL BEARING, ROLLER BEARING OR PLAIN BEARING.

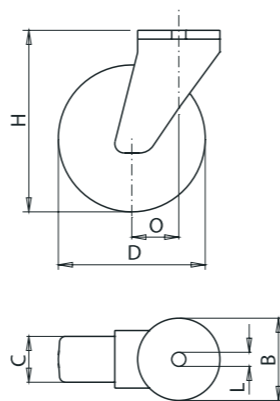

## KOLESA S STABILNIMI VILICAMI

CINKANE JEKLENE VILICE, PLATIŠČE IZ POLIAMIDA, NALITA GUMA-ELASTIK (70 ShA), KROGLIČNI, VALJČNI ALI DRSNI LEŽAJ.

### FIXED CASORS

ZINC ELECTRO-PLATED STEEL FORKS, POLYAMIDE WHEEL CENTRE, NON-MARKING SOFT RUBBER TREAD (70 ShA), BALL BEARING, ROLLER BEARING OR PLAIN BEARING.

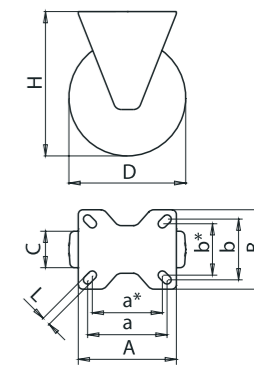

ident.	ident.	D mm	C mm		L mm	B mm	O mm	H mm	kg	kg	ident.	D mm	C mm		AxB mm	a/a*xb/b* mm	L mm	H mm	kg	kg
40213	40253	100	35	☐	12,5	70	40	128	0,92	150	39883	100	35	☐	105x85	85/75x65/55	9	128	0,57	150
40205	40245	100	35	☐	12,5	70	40	128	0,87	150	39875	100	35	☐	105x85	85/75x65/55	9	128	0,52	150
40204	40244	100	35	☐	12,5	70	40	128	0,83	150	39874	100	35	☐	105x85	85/75x65/55	9	128	0,48	150
40223	40263	125	35	☐	12,5	70	40	155	1,04	200	39893	125	35	☐	105x85	85/75x65/55	9	155	0,69	200
40215	40255	125	35	☐	12,5	70	40	155	0,99	200	39885	125	35	☐	105x85	85/75x65/55	9	155	0,64	200
40214	40254	125	35	☐	12,5	70	40	155	0,95	200	39884	125	35	☐	105x85	85/75x65/55	9	155	0,60	200
40233	40273	160	50	☐	12,5	93	50	190	1,73	300	39903	160	50	☐	135x110	110/100x85/75	11	190	1,15	300
40225	40265	160	50	☐	12,5	93	50	190	1,64	300	39895	160	50	☐	135x110	110/100x85/75	11	190	1,10	300
40224	40264	160	50	☐	12,5	93	50	190	1,58	300	39894	160	50	☐	135x110	110/100x85/75	11	190	1,00	300
40243	40283	200	50	☐	12,5	93	60	232	3,33	300	39913	200	50	☐	135x110	110/100x85/75	11	232	2,21	300
40235	40275	200	50	☐	12,5	93	60	232	3,17	300	39905	200	50	☐	135x110	110/100x85/75	11	232	2,05	300
40234	40274	200	50	☐	12,5	93	60	232	3,04	300	39904	200	50	☐	135x110	110/100x85/75	11	232	1,92	300

### RAZLIČICE - DODATKI / VARIETIES - ACCESSORIES



**Kovinski pokrov:** velik  
**Platišče:** barva po dogovoru  
**Guma-elastik:** barva po dogovoru  
**Pritrdilna luknja:** po dogovoru

**Metal treadguard:** big  
**Wheel centre:** color upon request  
**Non-marking soft rubber tread:** color upon request  
**Single bolt housing:** upon request



**Pritrdilni čep:** po dogovoru  
**Stem housing:** upon request

Za doseganje max. nosilnosti, mora biti podprta celotna površina prirobnice.  
To reach max. load capacity the total surface of the plate must be supported.

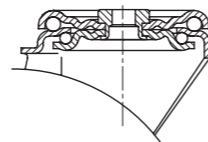

### RAZLIČICE - DODATKI / VARIETIES - ACCESSORIES



**Kovinski pokrov:** velik  
**Platišče:** barva po dogovoru  
**Guma-elastik:** barva po dogovoru

**Metal treadguard:** big  
**Wheel centre:** color upon request  
**Non-marking soft rubber tread:** color upon request

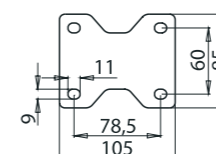

**Priroba DIN:** za kolesa Ø100, Ø125  
**DIN top plate:** for castors Ø100, Ø125



## KOLESA Z VILICAMI

CINKANE JEKLENE VILICE, KOLO IZ POLIPROPILENA (PP) ALI POLIAMIDA (PA), ČRNE ALI NATUR BELE BARVE, VALJČNI LEŽAJ.

## SWIVEL AND FIXED CASTORS

ZINC ELECTRO-PLATED STEEL FORKS, POLYPROPYLENE (PP) OR POLYAMIDE (PA) SOLID WHEEL, BLACK OR NATURAL WHITE COLOUR, ROLLER BEARING.



### Kolesa brez vilic / Wheels

PP - črn PP - black	PP - bel PP - white	PA - črn PA - black	PA - bel PA - white	D mm	C mm	F mm	W mm	kg	PP kg	PA kg
ident.	ident.	ident.	ident.	108	36	12	44	0,15	150	200
68979	91402	91403	91404							

### Kolesa z gibljivimi vilicami / Swivel Castors

PP - črn PP - black	PP - bel PP - white	PA - črn PA - black	PA - bel PA - white	D mm	C mm	mm	mm	mm	mm	mm	kg	PP kg	PA kg
ident.	ident.	ident.	ident.	108	36	105x85	80x60	9	40	132	0,68	150	200
91621	31805	31814	91799										

### Kolesa s stabilnimi vilicami / Fixed Castors

PP - črn PP - black	PP - bel PP - white	PA - črn PA - black	PA - bel PA - white	D mm	C mm	mm	mm	mm	mm	kg	PP kg	PA kg
ident.	ident.	ident.	ident.	108	36	105x85	80x60	9	132	0,46	150	200
91623	31813	31815	91800									

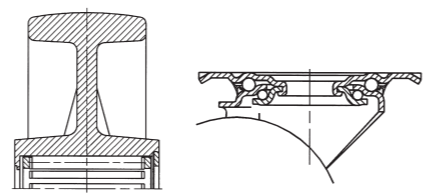

Blank lined area for notes or specifications, starting with a pencil icon at the top left.



**KOLESA  
IZ NERJAVEČE  
PLOČEVINE**



**STAINLESS  
STEEL CASTORS  
AND WHEELS**







## KOLESA Z INOX GIBLJIVIMI VILICAMI

VILICE IZ NERJAVEČE PLOČEVINE, PLATIŠČE IZ POLIPROPILENA, GUMI OBROČ (83 ShA), VALJČNI ALI DRSNI LEŽAJ.

### INOX SWIVEL CASTORS

STAINLESS STEEL FORKS, POLYPROPYLEN WHEEL CENTRE, RUBBER TYRE (83 ShA), ROLLER BEARING OR PLAIN BEARING.

**INOX**  
AISI 430

## KOLESA Z INOX GIBLJIVIMI VILICAMI - PRITRDILNA LUKNJA

VILICE IZ NERJAVEČE PLOČEVINE, PLATIŠČE IZ POLIPROPILENA, GUMI OBROČ (83 ShA), VALJČNI ALI DRSNI LEŽAJ.

### INOX SWIVEL CASTORS - SINGLE BOLT HOUSING

STAINLESS STEEL FORKS, POLYPROPYLEN WHEEL CENTRE, RUBBER TYRE (83 ShA), ROLLER BEARING OR PLAIN BEARING.

**INOX**  
AISI 430

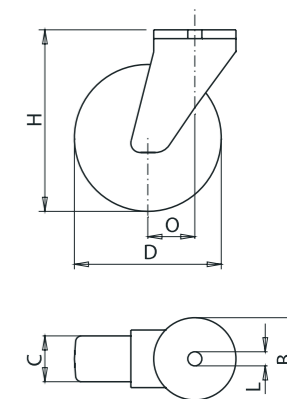
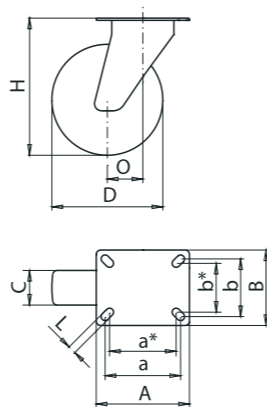

ident.	ident.	D mm	C mm		AxB mm	a/a*xb/b* mm	L mm	O mm	H mm	kg	kg	ident.	ident.	D mm	C mm		L mm	B mm	O mm	H mm	kg	kg
41485	41505	80	30	≡	105x85	85/75x65/55	9	34	106	0,75	65	41525	41545	80	30	≡	12,5	70	34	106	0,75	65
41493	41513	80	30	≡	105x85	85/75x65/55	9	34	106	0,73	65	41533	41553	80	30	≡	12,5	70	34	106	0,73	65
41494	41514	100	32	≡	105x85	85/75x65/55	9	40	128	0,87	80	41534	41554	100	32	≡	12,5	70	40	128	0,87	80
41495	41515	100	32	≡	105x85	85/75x65/55	9	40	128	0,85	80	41535	41555	100	32	≡	12,5	70	40	128	0,85	80
41503	41523	125	37	≡	105x85	85/75x65/55	9	40	155	1,12	100	41543	41563	125	37	≡	12,5	70	40	155	1,12	100
41504	41524	125	37	≡	105x85	85/75x65/55	9	40	155	1,10	100	41544	41564	125	37	≡	12,5	70	40	155	1,10	100
41863	41885	150	40	≡	135x110	110/100x85/75	11	50	180	2,27	170	41914	41943	150	40	≡	12,5	93	50	180	2,27	170
41864	41893	150	40	≡	135x110	110/100x85/75	11	50	180	2,17	170	41915	41944	150	40	≡	12,5	93	50	180	2,17	170
41865	41894	160	40	≡	135x110	110/100x85/75	11	50	190	2,34	180	41923	41945	160	40	≡	12,5	93	50	190	2,34	180
41873	41895	160	40	≡	135x110	110/100x85/75	11	50	190	2,24	180	41924	41953	160	40	≡	12,5	93	50	190	2,24	180
41874	41903	180	50	≡	135x110	110/100x85/75	11	55	210	2,70	200	41925	41954	180	50	≡	12,5	93	55	210	2,70	200
41875	41904	180	50	≡	135x110	110/100x85/75	11	55	210	2,60	200	41933	41955	180	50	≡	12,5	93	55	210	2,60	200
41883	41905	200	50	≡	135x110	110/100x85/75	11	60	232	2,94	230	41934	41963	200	50	≡	12,5	93	60	232	2,94	230
41884	41913	200	50	≡	135x110	110/100x85/75	11	60	232	2,84	230	41935	41964	200	50	≡	12,5	93	60	232	2,84	230

#### RAZLIČICE - DODATKI / VARIETIES - ACCESSORIES



**Platišče:** barva po dogovoru  
**Kovinski pokrov:** velik

**Wheel centre:** color upon request  
**Metal treadguard:** big

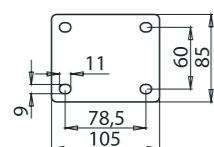

**Priroba DIN:** za kolesa Ø80 - Ø125

**DIN top plate:** for castors Ø80 - Ø125

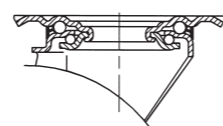

#### RAZLIČICE - DODATKI / VARIETIES - ACCESSORIES



**Pritrdilna luknja:** po dogovoru  
**Platišče:** barva po dogovoru  
**Kovinski pokrov:** velik

**Single bolt housing:** upon request  
**Wheel centre:** color upon request  
**Metal treadguard:** big

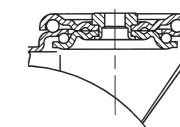

Za doseganje max. nosilnosti, mora biti podprta celotna površina prirobnice.  
To reach max. load capacity the total surface of the plate must be supported.

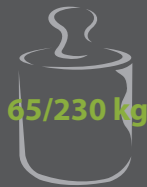

## KOLESA Z INOX STABILNIMI VILICAMI

VILICE IZ NERJAVEČE PLOČEVINE, PLATIŠČE IZ POLIPROPILENA, GUMI OBROČ (83 ShA), VALJČNI ALI DRSNI LEŽAJ.

### INOX FIXED CASTORS

STAINLESS STEEL FORKS, POLYPROPYLENE WHEEL CENTRE, RUBBER TYRE (83 ShA), ROLLER BEARING OR PLAIN BEARING.



## KOLESA Z INOX GIBLJIVIMI VILICAMI

VILICE IZ NERJAVEČE PLOČEVINE, KOLO IZ POLIAMIDA (PA), NATUR BELE BARVE, VALJČNI ALI DRSNI LEŽAJ.

### INOX SWIVEL CASTORS

STAINLESS STEEL FORKS, POLYAMIDE (PA) SOLID WHEEL, NATURAL WHITE COLOUR, ROLLER BEARING OR PLAIN BEARING.

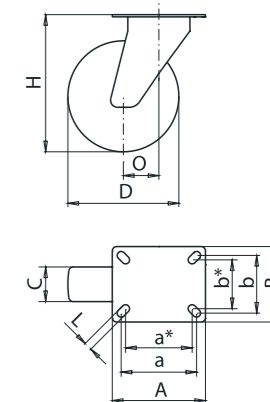
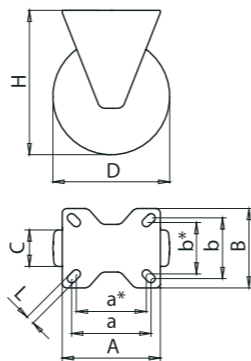

ident.	D mm	C mm		AxB mm	a/a*xb/b* mm	L mm	mm	kg	kg	ident.	ident.	D mm	C mm		AxB mm	a/a*xb/b* mm	L mm	O mm	H mm	kg	kg	
41465	80	30		105x85	85/75x65/55	9	106	0,44	65	41273	41293	80	35		105x85	85/75x65/55	9	34	106	0,63	200	
41473	80	30		105x85	85/75x65/55	9	106	0,42	65	41274	41294	80	35		105x85	85/75x65/55	9	34	106	0,59	200	
41474	100	32		105x85	85/75x65/55	9	128	0,56	80	41275	41295	100	35		105x85	85/75x65/55	9	40	128	0,65	200	
41475	100	32		105x85	85/75x65/55	9	128	0,54	80	41283	41303	100	35		105x85	85/75x65/55	9	40	128	0,61	250	
41483	125	37		105x85	85/75x65/55	9	155	0,80	100	41284	41304	125	38		105x85	85/75x65/55	9	40	155	0,70	250	
41484	125	37		105x85	85/75x65/55	9	155	0,78	100	41285	41305	125	38		105x85	85/75x65/55	9	40	155	0,66	300	
41834	150	40		135x110	110/100x85/75	11	180	1,60	170	41645	41663	150	46		135x110	110/100x85/75	11	50	180	1,70	350	
41835	150	40		135x110	110/100x85/75	11	180	1,50	170	41653	41664	150	46		135x110	110/100x85/75	11	50	180	1,60	400	
41843	160	40		135x110	110/100x85/75	11	190	1,67	180	41654	41665	200	50		135x110	110/100x85/75	11	60	232	2,10	350	
41844	160	40		135x110	110/100x85/75	11	190	1,57	180	41655	41673	200	50		135x110	110/100x85/75	11	60	232	2,00	400	
41845	180	50		135x110	110/100x85/75	11	210	2,03	200													
41853	180	50		135x110	110/100x85/75	11	210	1,93	200													
41854	200	50		135x110	110/100x85/75	11	232	2,28	230													
41855	200	50		135x110	110/100x85/75	11	232	2,18	230													

#### RAZLIČICE - DODATKI / VARIETIES - ACCESSORIES

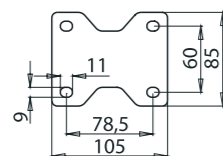

Platišče: barva po dogovoru  
Kovinski pokrov: velik

Priroba DIN: za kolesa Ø80 - Ø125

DIN top plate: for castors Ø80 - Ø125

Wheel centre: color upon request  
Metal treadguard: big

#### RAZLIČICE - DODATKI / VARIETIES - ACCESSORIES

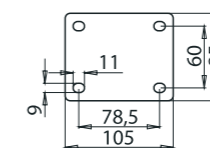

Kovinski pokrov: velik, mali (za kolesa Ø80 - Ø125)

Metal treadguard: big, small (for castors Ø80 - Ø125)

Priroba DIN: za kolesa Ø80 - Ø125

DIN top plate: for castors Ø80 - Ø125

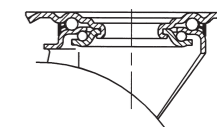



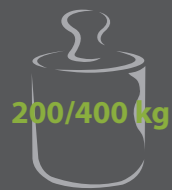

## KOLESA Z INOX GIBLJIVIMI VILICAMI - PRITRDILNA LUKNJA

VILICE IZ NERJAVEČE PLOČEVINE, KOLO IZ POLIAMIDA (PA), NATUR BELE BARVE, VALJČNI ALI DRSNI LEŽAJ.

### INOX SWIVEL CASTORS - SINGLE BOLT HOUSING

STAINLESS STEEL FORKS, POLYAMIDE (PA) SOLID WHEEL, NATURAL WHITE COLOUR, ROLLER BEARING OR PLAIN BEARING.



## KOLESA Z INOX STABILNIMI VILICAMI

VILICE IZ NERJAVEČE PLOČEVINE, KOLO IZ POLIAMIDA (PA), NATUR BELE BARVE, VALJČNI ALI DRSNI LEŽAJ.

### INOX FIXED CASTORS

STAINLESS STEEL FORKS, POLYAMIDE (PA) SOLID WHEEL, NATURAL WHITE COLOUR, ROLLER BEARING OR PLAIN BEARING.

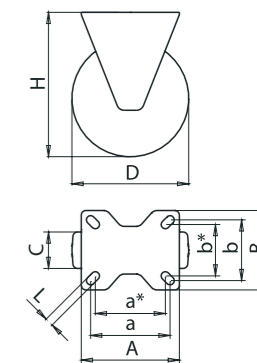
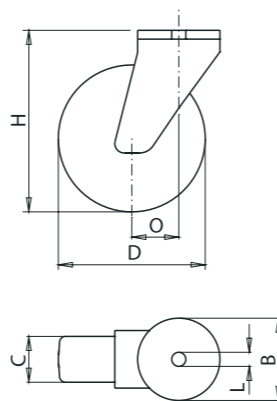

ident.	ident.	D mm	C mm		L mm	B mm	O mm	H mm	kg	kg	ident.	D mm	C mm		AxB mm	a/a*xb/b* mm	L mm	H mm	kg	kg
41313	41333	80	35	☰	12,5	70	34	106	0,63	200	41253	80	35	☰	105x85	85/75x65/55	9	106	0,53	200
41314	41334	80	35	☱	12,5	70	34	106	0,59	200	41254	80	35	☱	105x85	85/75x65/55	9	106	0,49	200
41315	41335	100	35	☰	12,5	70	40	128	0,65	200	41255	100	35	☰	105x85	85/75x65/55	9	128	0,55	200
41323	41343	100	35	☱	12,5	70	40	128	0,61	250	41263	100	35	☱	105x85	85/75x65/55	9	128	0,51	250
41324	41344	125	38	☰	12,5	70	40	155	0,70	250	41264	125	38	☰	105x85	85/75x65/55	9	155	0,62	250
41325	41345	125	38	☱	12,5	70	40	155	0,66	300	41265	125	38	☱	105x85	85/75x65/55	9	155	0,58	300
41674	41685	150	46	☰	12,5	93	50	180	1,70	350	41634	150	46	☰	135x110	110/100x85/75	11	180	1,30	350
41675	41693	150	46	☱	12,5	93	50	180	1,60	400	41635	150	46	☱	135x110	110/100x85/75	11	180	1,20	400
41683	41694	200	50	☰	12,5	93	60	232	2,10	350	41643	200	50	☰	135x110	110/100x85/75	11	232	1,65	350
41684	41695	200	50	☱	12,5	93	60	232	2,00	400	41644	200	50	☱	135x110	110/100x85/75	11	232	1,55	400

#### RAZLIČICE - DODATKI / VARIETIES - ACCESSORIES



**Pritrdilna luknja:** po dogovoru  
**Kovinski pokrov:** velik, mali (za kolesa Ø80 - Ø125)  
**Single bolt housing:** upon request  
**Metal treadguard:** big, small (for castors Ø80 - Ø125)

Za doseganje max. nosilnosti, mora biti podprta celotna površina prirobnice.  
 To reach max. load capacity the total surface of the plate must be supported.

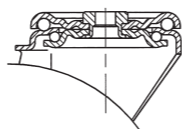

#### RAZLIČICE - DODATKI / VARIETIES - ACCESSORIES



**Kovinski pokrov:** velik, mali (za kolesa Ø80 - Ø125)  
**Metal treadguard:** big, small (for castors Ø80 - Ø125)

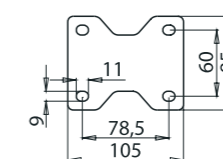

**Priroba DIN:** za kolesa Ø80 - Ø125  
**DIN top plate:** for castors Ø80 - Ø125



## KOLESA

PLATIŠČE IZ POLIAMIDA, POLIURETAN OBLOGA (92 ShA), KROGLIČNI, VALJČNI ALI DRSNI LEŽAJ.

## WHEELS

POLYAMIDE WHEEL CENTRE, POLYURETHANE TREAD (92 ShA), BALL BEARING, ROLLER BEARING OR PLAIN BEARING.

**INOX**  
AISI 430

## KOLESA Z INOX GIBLJIVIMI VILICAMI

VILICE IZ NERJAVEČE PLOČEVINE, PLATIŠČE IZ POLIAMIDA, POLIURETAN OBLOGA (92 ShA), KROGLIČNI, VALJČNI ALI DRSNI LEŽAJ.

## INOX SWIVEL CASTORS

STAINLESS STEEL FORKS, POLYAMIDE WHEEL CENTRE, POLYURETHANE TREAD (92 ShA), BALL BEARING, ROLLER BEARING OR PLAIN BEARING.

**INOX**  
AISI 430

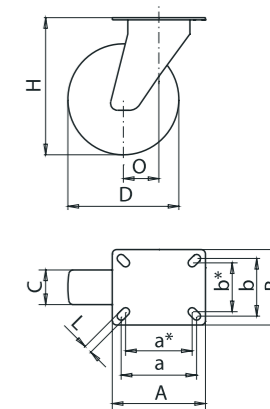
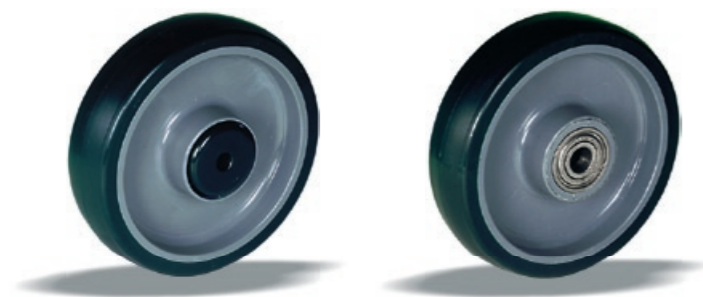

2

Ident.	D mm	C mm	F mm	W mm	kg	kg	ident.	D mm	C mm	AxB mm	a/a*xb/b* mm	L mm	O mm	H mm	kg	kg	
42135	100	32	12	44	0,30	150	42165	42183	100	32	105x85	85/75x65/55	9	40	128	0,92	150
42945	100	32	8,5	44	0,27	150	41364	41375	100	32	105x85	85/75x65/55	9	40	128	0,87	150
43085	100	32	8,5	44	0,23	150	41365	41383	100	32	105x85	85/75x65/55	9	40	128	0,83	150
42143	125	32	12	44	0,37	200	42173	42184	125	32	105x85	85/75x65/55	9	40	155	1,04	200
43035	125	32	8,5	44	0,34	200	41373	41384	125	32	105x85	85/75x65/55	9	40	155	0,99	200
43095	125	32	8,5	44	0,30	200	41374	41385	125	32	105x85	85/75x65/55	9	40	155	0,95	200
42294	160	50	20	58	0,65	400	42174	42185	160	50	135x110	110/100x85/75	11	50	190	1,73	300
43104	160	50	12,5	58	0,60	400	41714	41725	160	50	135x110	110/100x85/75	11	50	190	1,64	300
43105	160	50	12,5	58	0,50	400	41715	41733	160	50	135x110	110/100x85/75	11	60	190	1,58	300
42295	200	50	20	58	1,10	500	42175	42193	200	50	135x110	110/100x85/75	11	60	232	3,33	300
43114	200	50	12,5	58	1,00	500	41723	41734	200	50	135x110	110/100x85/75	11	60	232	3,17	300
43115	200	50	12,5	58	0,95	500	41724	41735	200	50	135x110	110/100x85/75	11	60	232	3,04	300

### RAZLIČICE - DODATKI / VARIETIES - ACCESSORIES

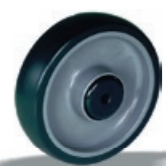

Platišče: barva po dogovoru  
Poliuretanska obloga: barva po dogovoru

Wheel centre: color upon request  
Polyurethane tread: color upon request

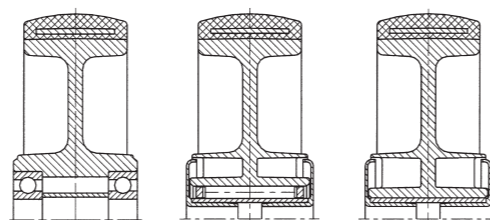

### RAZLIČICE - DODATKI / VARIETIES - ACCESSORIES



Platišče: barva po dogovoru  
Poliuretanska obloga: barva po dogovoru  
Kovinski pokrov: velik

Wheel centre: color upon request  
Polyurethane tread: color upon request  
Metal treadguard: big

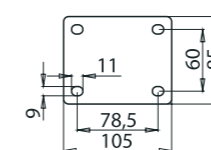

Priroba DIN: za kolesa Ø100, Ø125  
DIN top plate: for castors Ø100, Ø125

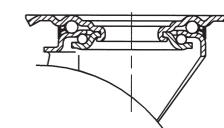

43

42





## KOLESA Z INOX GIBLJIVIMI VILICAMI - PRITRDILNA LUKNJA

VILICE IZ NERJAVEČE PLOČEVINE, PLATIŠČE IZ POLIAMIDA, POLIURETAN OBLOGA (92 ShA), KROGLIČNI, VALJČNI ALI DRSNI LEŽAJ.

### INOX SWIVEL CASTORS - SINGLE BOLT HOUSING

STAINLESS STEEL FORKS, POLYAMIDE WHEEL CENTRE, POLYURETHANE TREAD (92 ShA), BALL BEARING, ROLLER BEARING OR PLAIN BEARING.



## KOLESA Z INOX STABILNIMI VILICAMI

VILICE IZ NERJAVEČE PLOČEVINE, PLATIŠČE IZ POLIAMIDA, POLIURETAN OBLOGA (92 ShA), KROGLIČNI, VALJČNI ALI DRSNI LEŽAJ.

### INOX FIXED CASTORS

STAINLESS STEEL FORKS, POLYAMIDE WHEEL CENTRE, POLYURETHANE TREAD (92 ShA), BALL BEARING, ROLLER BEARING OR PLAIN BEARING.

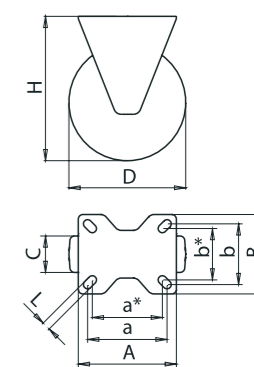
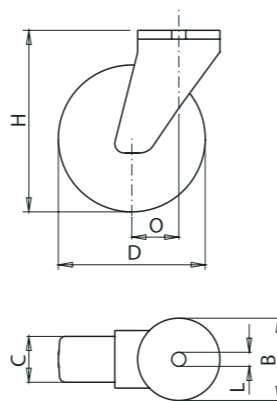

ident.	ident.	D mm	C mm		L mm	B mm	O mm	H mm	kg	kg	ident.	D mm	C mm		AxB mm	a/a*x/b/b* mm	L mm	H mm	kg	kg
42194	42205	100	32	☉	12,5	70	40	128	0,92	150	42154	100	32	☉	105x85	85/75x65/55	9	128	0,57	150
41393	41404	100	32	☉	12,5	70	40	128	0,87	150	41353	100	32	☉	105x85	85/75x65/55	9	128	0,52	150
41394	41405	100	32	☉	12,5	70	40	128	0,83	150	41354	100	32	☉	105x85	85/75x65/55	9	128	0,48	150
42195	42213	125	32	☉	12,5	70	40	155	1,04	200	42155	125	32	☉	105x85	85/75x65/55	9	155	0,60	200
41395	41413	125	32	☉	12,5	70	40	155	0,99	200	41355	125	32	☉	105x85	85/75x65/55	9	155	0,64	200
41403	41414	125	32	☉	12,5	70	40	155	0,95	200	41363	125	32	☉	105x85	85/75x65/55	9	155	0,69	200
42203	42214	160	50	☉	12,5	93	50	190	1,73	300	42163	160	50	☉	135x110	110/100x85/75	11	190	1,15	300
41743	41754	160	50	☉	12,5	93	50	190	1,64	300	41703	160	50	☉	135x110	110/100x85/75	11	190	1,10	300
41744	41755	160	50	☉	12,5	93	60	190	1,58	300	41704	160	50	☉	135x110	110/100x85/75	11	190	1,00	300
42204	42215	200	50	☉	12,5	93	60	232	3,33	300	42164	200	50	☉	135x110	110/100x85/75	11	232	2,21	300
41745	41763	200	50	☉	12,5	93	60	232	3,17	300	41705	200	50	☉	135x110	110/100x85/75	11	232	2,05	300
41753	41764	200	50	☉	12,5	93	60	232	3,04	300	41713	200	50	☉	135x110	110/100x85/75	11	232	1,92	300

#### RAZLIČICE - DODATKI / VARIETIES - ACCESSORIES



**Pritrdilna luknja:** po dogovoru  
**Platišče:** barva po dogovoru  
**Poliuretanska obloga:** barva po dogovoru  
**Kovinski pokrov:** velik

**Single bolt housing:** upon request  
**Wheel centre:** color upon request  
**Polyurethane tread:** color upon request  
**Metal treadguard:** big

Za doseganje max. nosilnosti, mora biti podprta celotna površina prirobnice.  
To reach max. load capacity the total surface of the plate must be supported.

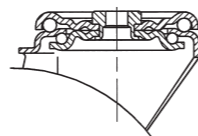

#### RAZLIČICE - DODATKI / VARIETIES - ACCESSORIES



**Kovinski pokrov:** velik  
**Metal treadguard:** big

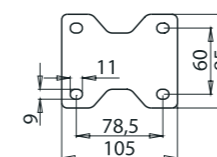

**Priroba DIN:** za kolesa Ø80 - Ø125  
**DIN top plate:** for castors Ø80 - Ø125

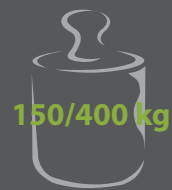

## KOLESA

PLATIŠČE IZ POLIAMIDA, NALITA GUMA-ELASTIK (70 ShA), KROGLIČNI, VALJČNI ALI DRSNI LEŽAJ.

## WHEELS

POLYAMIDE WHEEL CENTRE, NON-MARKING SOFT RUBBER TREAD (70 ShA), BALL BEARING, ROLLER BEARING OR PLAIN BEARING.



## KOLESA Z INOX GIBLJIVIMI VILICAMI

VILICE IZ NERJAVEČE PLOČEVINE, PLATIŠČE IZ POLIAMIDA, NALITA GUMA - ELASTIK (70 ShA), KROGLIČNI, VALJČNI ALI DRSNI LEŽAJ.

## INOX SWIVEL CASTORS

STAINLESS STEEL FORKS, POLYAMIDE WHEEL CENTRE, NON-MARKING SOFT RUBBER TREAD (70 ShA), BALL BEARING, ROLLER BEARING OR PLAIN BEARING.

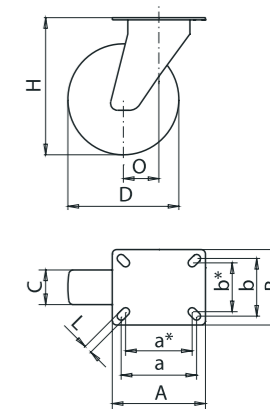

Ident.	D mm	C mm	F mm	W mm	kg	kg	ident.	ident.	D mm	C mm	AxB mm	a/a*xb/b* mm	L mm	O mm	H mm	kg	kg
42144	100	35	12	44	0,30	150	42234	42245	100	35	105x85	85/75x65/55	9	40	128	0,92	150
42314	100	35	8,5	44	0,27	150	41583	41594	100	35	105x85	85/75x65/55	9	40	128	0,87	150
44009	100	35	8,5	44	0,23	150	41584	41595	100	35	105x85	85/75x65/55	9	40	128	0,83	150
42153	125	35	12	44	0,37	200	42235	42253	125	35	105x85	85/75x65/55	9	40	155	1,04	200
42315	125	35	8,5	44	0,34	200	41585	41603	125	35	105x85	85/75x65/55	9	40	155	0,99	200
44010	125	35	8,5	44	0,30	200	41593	41604	125	35	105x85	85/75x65/55	9	40	155	0,95	200
42303	160	50	20	58	0,65	350	42243	42254	160	50	135x110	110/100x85/75	11	50	190	1,73	300
42305	160	50	12,5	58	0,60	350	41783	41794	160	50	135x110	110/100x85/75	11	50	190	1,64	300
44011	160	50	12,5	58	0,50	350	41784	41795	160	50	135x110	110/100x85/75	11	50	190	1,58	300
42304	200	50	20	58	1,10	400	42244	42255	200	50	135x110	110/100x85/75	11	60	232	3,33	300
42313	200	50	12,5	58	1,00	400	41785	41803	200	50	135x110	110/100x85/75	11	60	232	3,17	300
44012	200	50	12,5	58	0,95	400	41793	41804	200	50	135x110	110/100x85/75	11	60	232	3,04	300

### RAZLIČICE - DODATKI / VARIETIES - ACCESSORIES



**Platišče:** barva po dogovoru  
**Guma-elastik obloga:** barva po dogovoru  
**Wheel centre:** color upon request  
**Non-marking soft rubber tread:** color upon request

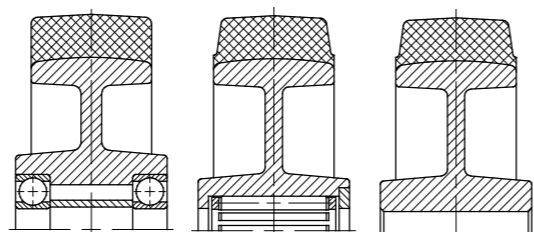

### RAZLIČICE - DODATKI / VARIETIES - ACCESSORIES



**Platišče:** barva po dogovoru  
**Guma-elastik obloga:** barva po dogovoru  
**Kovinski pokrov:** velik  
**Wheel centre:** color upon request  
**Non-marking soft rubber tread:** color upon request  
**Metal treadguard:** big

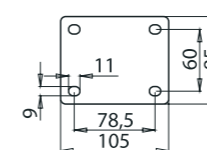

**Priroba DIN:** za kolesa Ø100, Ø125  
**DIN top plate:** for castors Ø100, Ø125

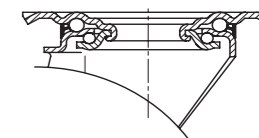





## KOLESA Z INOX GIBLJIVIMI VILICAMI - PRITRDILNA LUKNJA

VILICE IZ NERJAVEČE PLOČEVINE, PLATIŠČE IZ POLIAMIDA, NALITA GUMA - ELASTIK (70 ShA), KROGLIČNI, VALJČNI ALI DRSNI LEŽAJ.

**INOX**  
AISI 430

## INOX SWIVEL CASTORS - SINGLE BOLT HOUSING

STAINLESS STEEL FORKS, POLYAMIDE WHEEL CENTRE, NON-MARKING SOFT RUBBER TREAD (70 ShA), BALL BEARING, ROLLER BEARING OR PLAIN BEARING.

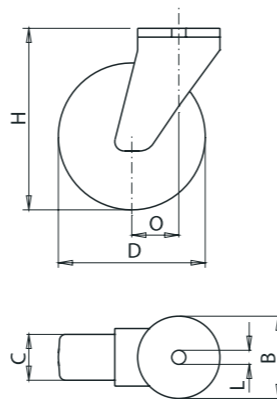

## KOLESA Z INOX STABILNIMI VILICAMI

VILICE IZ NERJAVEČE PLOČEVINE, PLATIŠČE IZ POLIAMIDA, NALITA GUMA - ELASTIK (70 ShA), KROGLIČNI ALI DRSNI LEŽAJ.

**INOX**  
AISI 430

## INOX FIXED CASTORS

STAINLESS STEEL FORKS, POLYAMIDE WHEEL CENTRE, NON-MARKING SOFT RUBBER TREAD (70 ShA), BALL BEARING OR PLAIN BEARING.

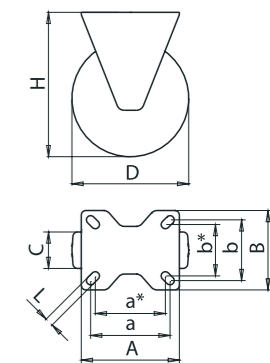

ident.	ident.	D mm	C mm		L mm	B mm	O mm	H mm	kg	kg	ident.	D mm	C mm		AxB mm	a/a*xb/b* mm	L mm	H mm	kg	kg
42263	42274	100	35	●●	12,5	70	40	128	0,92	150	42223	100	35	●●	105x85	85/75x65/55	9	128	0,57	150
41605	41623	100	35	≡	12,5	70	40	128	0,87	150	43365	100	35	≡	105x85	85/75x65/55	9	128	0,52	150
41613	41624	100	35	≡	12,5	70	40	128	0,83	150	41573	100	35	≡	105x85	85/75x65/55	9	128	0,48	150
42264	42275	125	35	●●	12,5	70	40	155	1,04	200	42224	125	35	●●	105x85	85/75x65/55	9	155	0,60	200
41614	41625	125	35	≡	12,5	70	40	155	0,99	200	43373	125	35	≡	105x85	85/75x65/55	9	155	0,64	200
41615	41633	125	35	≡	12,5	70	40	155	0,95	200	41575	125	35	≡	105x85	85/75x65/55	9	155	0,69	200
42265	42283	160	50	●●	12,5	93	50	190	1,73	300	42225	160	50	●●	135x110	110/100x85/75	11	190	1,15	300
41805	41823	160	50	≡	12,5	93	50	190	1,64	300	41765	160	50	≡	135x110	110/100x85/75	11	190	1,10	300
41813	41824	160	50	≡	12,5	93	60	190	1,58	300	41773	160	50	≡	135x110	110/100x85/75	11	190	1,00	300
42273	42284	200	50	●●	12,5	93	60	232	3,33	300	42233	200	50	●●	135x110	110/100x85/75	11	232	2,21	300
41814	41825	200	50	≡	12,5	93	60	232	3,17	300	41774	200	50	≡	135x110	110/100x85/75	11	232	2,05	300
41815	41833	200	50	≡	12,5	93	60	232	3,04	300	41775	200	50	≡	135x110	110/100x85/75	11	232	1,92	300

### RAZLIČICE - DODATKI / VARIETIES - ACCESSORIES



**Pritrdilna luknja:** po dogovoru  
**Platišče:** barva po dogovoru  
**Guma-elastik obloga:** barva po dogovoru  
**Kovinski pokrov:** velik  
**Single bolt housing:** upon request  
**Wheel centre:** color upon request  
**Non-marking soft rubber tread:** color upon request  
**Metal treadguard:** big

Za doseganje max. nosilnosti, mora biti podprta celotna površina prirobnice.  
 To reach max. load capacity the total surface of the plate must be supported.

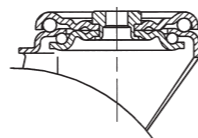

### RAZLIČICE - DODATKI / VARIETIES - ACCESSORIES



**Platišče:** barva po dogovoru  
**Guma-elastik obloga:** barva po dogovoru  
**Kovinski pokrov:** velik  
**Wheel centre:** color upon request  
**Non-marking soft rubber tread:** color upon request  
**Metal treadguard:** big

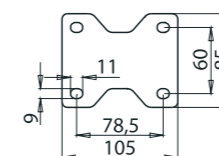

**Priroba DIN:** za kolesa Ø80 - Ø125  
**DIN top plate:** for castors Ø80 - Ø125



**KOLESA ZA  
KONTEJNERJE**



**CASTORS AND  
WHEELS FOR  
MOBILE WASTE  
CONTAINERS**





## KOLESA Z GIBLJIVIMI VILICAMI

CINKANE JEKLENE VILICE, CINKANO JEKLENO PLATIŠČE, GUMI OBROČ (80 ShA), VALJČNI ALI DRSNI LEŽAJ.

### SWIVEL CASTORS

ZINC ELECTRO-PLATED STEEL FORKS, ZINC ELECTRO-PLATED WHEEL CENTRE, RUBBER TYRE (80 ShA), ROLLER BEARING OR PLAIN BEARING.

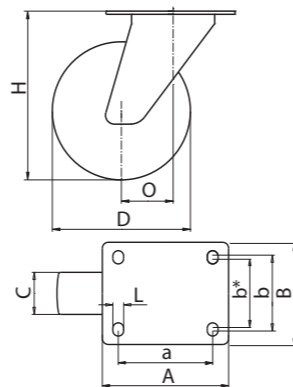
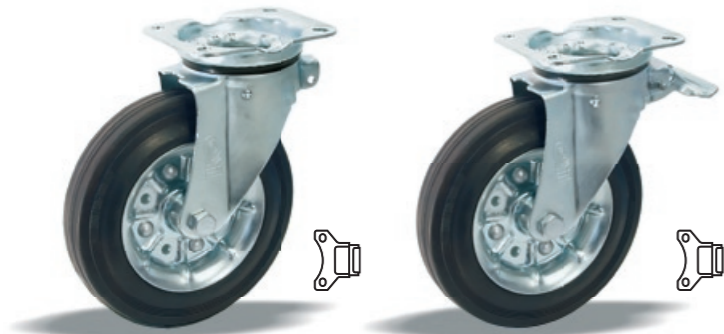

## KOLESA Z GIBLJIVIMI VILICAMI

CINKANE JEKLENE VILICE, PLATIŠČE IZ POLIPROPILENA, GUMI OBROČ (80 ShA), VALJČNI ALI DRSNI LEŽAJ.

### SWIVEL CASTORS

ZINC ELECTRO-PLATED STEEL FORKS, POLYPROPYLENE WHEEL CENTRE, RUBBER TYRE (80 ShA), ROLLER BEARING OR PLAIN BEARING.

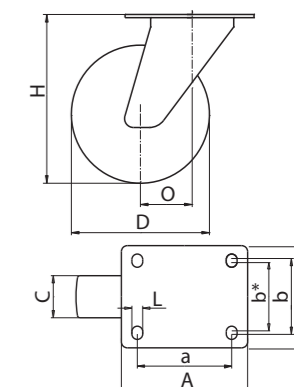
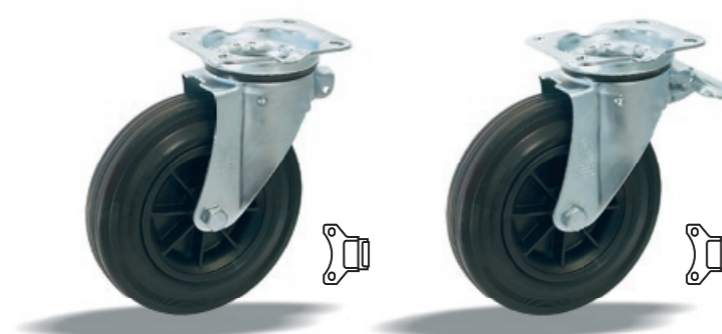

ident.	ident.	D mm	C mm		AxB mm	axb/b* mm	L mm	O mm	H mm	kg	kg	kg
44786	44787	160	40	≡	135x108	105x80/75	11	56	200	2,17	2,39	200
44335	44337	160	40	≡	135x108	105x80/75	11	56	200	2,10	2,31	200
44790	44792	200	50	≡	135x108	105x80/75	11	59	240	2,69	2,90	250
44341*	44343*	200	50	≡	135x108	105x80/75	11	59	240	2,62	2,83	250
47120	47121	200	50	≡	135x108	105x80/75	11	59	240	2,69	2,90	350

\* Testirano po standardih EN 850-5 in RAL-GZ 951/1-2. Certificirano na SKZ-TeConA GmbH.  
\* Tested according to EN 850-5 and RAL-GZ 951/1-2. Certified by SKZ-TeConA GmbH.



ident.	ident.	D mm	C mm		AxB mm	axb/b* mm	L mm	O mm	H mm	kg	kg	kg
44780	44781	160	40	≡	135x108	105x80/75	11	56	200	1,69	1,90	200
44336	44338	160	40	≡	135x108	105x80/75	11	56	200	1,62	1,83	200
44791	44793	200	50	≡	135x108	105x80/75	11	59	240	2,31	2,52	250
44761*	44762*	200	50	≡	135x108	105x80/75	11	59	240	2,23	2,45	250

\* Testirano po standardih EN 850-5 in RAL-GZ 951/1-2. Certificirano na SKZ-TeConA GmbH.  
\* Tested according to EN 850-5 and RAL-GZ 951/1-2. Certified by SKZ-TeConA GmbH.

### RAZLIČICE - DODATKI / VARIETIES - ACCESSORIES



**Zavora:** 3-STOP  
**Brake:** 3-STOP

**Priroba:** trikotna  
**Top plate:** triangular

**Zavora:** smerna (str. 55)  
**Directional locking device** (p. 55)

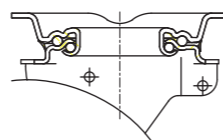

### RAZLIČICE - DODATKI / VARIETIES - ACCESSORIES



**Zavora:** 3-STOP  
**Brake:** 3-STOP

**Priroba:** trikotna  
**Top plate:** triangular

**Zavora:** smerna (str. 55)  
**Directional locking device** (p. 55)

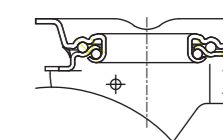

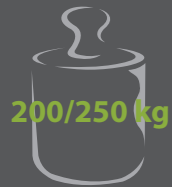

### KOLESA Z GIBLJIVIMI VILICAMI - CENTRALNA ZAVORA

CINKANE JEKLENE VILICE - CENTRALNA ZAVORA, CINKANO JEKLENO PLATIŠČE, GUMI OBROČ (80 ShA), VALJČNI ALI DRSNI LEŽAJ.

### SWIVEL CASTORS - CENTRAL TOTAL BREAK

ZINC ELECTRO-PLATED STEEL FORKS - CENTRAL TOTAL BREAK, ZINC ELECTRO-PLATED WHEEL CENTRE, RUBBER TYRE (80 ShA), ROLLER BEARING OR PLAIN BEARING.

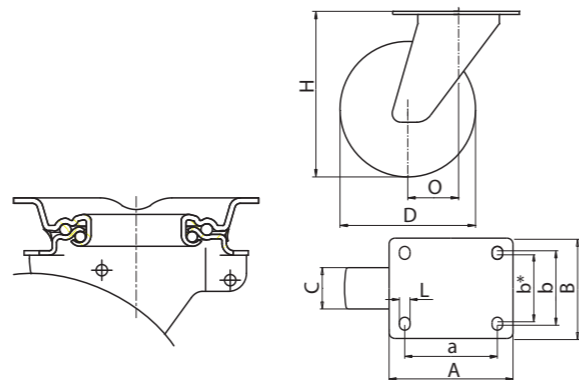

ident.	D mm	C mm	mm	AxB mm	axb/b* mm	L mm	O mm	H mm	kg	kg
44788	160	40	Ø38x34	135x108	105x80/75	11	56	200	2,36	200
44339	160	40	Ø38x34	135x108	105x80/75	11	56	200	2,28	200
44794	200	50	Ø38x34	135x108	105x80/75	11	59	240	2,88	250
44345*	200	50	Ø38x34	135x108	105x80/75	11	59	240	2,80	250



### KOLESA

PLASTIČNO PLATIŠČE, GUMI OBROČ (80 ShA), DRSNI LEŽAJ.

### WHEELS

PLASTIC WHEEL CENTRE, RUBBER TYRE (80 ShA), PLAIN BEARING.

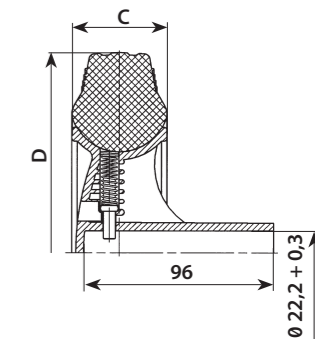

ident.	D mm	C mm	F mm	W mm	kg	kg
68947	200	50	22	95	1,20	160

### OS ZA PODALJŠANO PESTO / AXLE FOR THE EXTENDED HUB

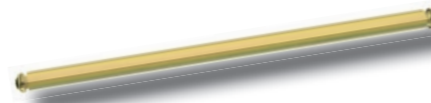

ident.	L mm	kg
44438	460	0,40
44311	550	0,50

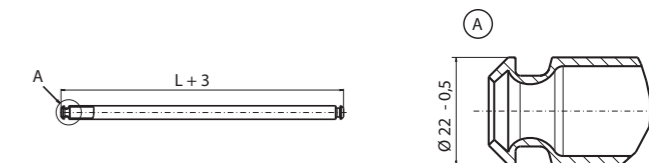

### KOLESA Z GIBLJIVIMI VILICAMI - CENTRALNA ZAVORA

CINKANE JEKLENE VILICE - CENTRALNA ZAVORA, POLIPROPILENSKO PLATIŠČE, GUMI OBROČ, VALJČNI ALI DRSNI LEŽAJ.

### SWIVEL CASTORS - CENTRAL TOTAL BREAK

ZINC ELECTRO-PLATED STEEL FORKS - CENTRAL TOTAL BREAK, POLYPROPYLENE WHEEL CENTRE, RUBBER TYRE, ROLLER BEARING OR PLAIN BEARING.

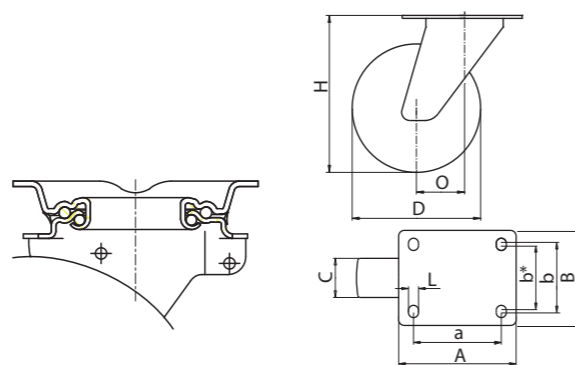

ident.	D mm	C mm	mm	AxB mm	axb/b* mm	L mm	O mm	H mm	kg	kg
44789	160	40	Ø38x34	135x108	105x80/75	11	56	200	1,88	200
44340	160	40	Ø38x34	135x108	105x80/75	11	56	200	1,81	200
44795	200	50	Ø38x34	135x108	105x80/75	11	59	240	2,49	250
44763*	200	50	Ø38x34	135x108	105x80/75	11	59	240	2,42	250

### ZAVORA GIBLJIVIH VILIC

CINKAN JEKLEN MEHANIZEM, VZMET IZ NERJAVEČEGA JEKLA.

### DIRECTIONAL LOCKING DEVICE

ZINC ELECTRO-PLATED STEEL MECHANISM, STAINLESS STEEL SPRING.



ident.	mm	mm	mm	kg
75168	80	11	68	0,26
33484	80	11	88	0,26
43917	105	11	81	0,28
43930	105	11	101	0,28

\* Testirano po standardih EN 850-5 in RAL-GZ 951/1-2. Certificirano na SKZ-TeConA GmbH.  
\* Tested according to EN 850-5 and RAL-GZ 951/1-2. Certified by SKZ-TeConA GmbH.



**KOLESA ZA  
TEŽJE DELOVNE  
POGOJE**



**HEAVY DUTY  
CASTORS  
AND WHEELS**







## KOLESA Z OJAČANIMI VILICAMI

OJAČANE CINKANE JEKLENE VILICE, KOLO IZ POLIAMIDA, VALJČNI, DRŠNI ALI KROGLIČNI LEŽAJ.

### REINFORCED SWIVEL AND FIXED CASTORS

ZINC ELECTRO-PLATED REINFORCED STEEL FORKS, POLYAMIDE SOLID WHEEL, ROLLER BEARING, PLAIN BEARING OR BALL BEARING.

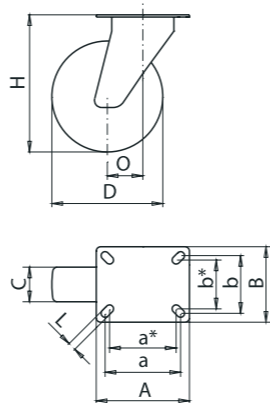

#### Kolesa z gibljivimi vilicami - priroba / Swivel Castors - Top Plate

PA - črn PA - black	PA - bel PA - white	PA - črn PA - black	PA - bel PA - white	D mm	C mm	AxB mm	a/a*xb/b* mm	L mm	O mm	H mm	kg	kg
40804	40805	40844	40845	80	35	105x85	85/75x65/55	9	40	109	0,87	200
40813	40814	40853	40854	80	35	105x85	85/75x65/55	9	40	109	0,83	200
40815	40823	40855	40863	100	35	105x85	85/75x65/55	9	40	131	0,87	200
40824	40825	40864	40865	100	35	105x85	85/75x65/55	9	40	131	0,83	250
40833	40834	40873	40874	125	38	105x85	85/75x65/55	9	40	158	0,99	250
40835	40843	40875	40883	125	38	105x85	85/75x65/55	9	40	158	0,95	300
	* 43413		* 43414	125	38	105x85	85/75x65/55	9	40	158	0,98	300
	** 44017		** 44019	125	38	105x85	85/75x65/55	9	40	158	1,13	350
	*** 44018		*** 44020	125	38	105x85	85/75x65/55	9	40	158	1,14	350

#### Kolesa s stabilnimi vilicami / Fixed Castors

PA - črn PA - black	PA - bel PA - white	D mm	C mm	AxB mm	a/a*xb/b* mm	L mm	H mm	kg	kg
40764	40765	80	35	105x85	85/75x65/55	9	109	0,52	200
40773	40774	80	35	105x85	85/75x65/55	9	109	0,48	200
40775	40783	100	35	105x85	85/75x65/55	9	131	0,52	200
40784	40785	100	35	105x85	85/75x65/55	9	131	0,48	250
40793	40794	125	38	105x85	85/75x65/55	9	158	0,64	250
40795	40803	125	38	105x85	85/75x65/55	9	158	0,69	300
	* 43405	125	38	105x85	85/75x65/55	9	158	0,73	300
	** 44014	125	38	105x85	85/75x65/55	9	158	0,78	350
	*** 44016	125	38	105x85	85/75x65/55	9	158	0,79	350

#### RAZLIČICE - DODATKI / VARIETIES - ACCESSORIES

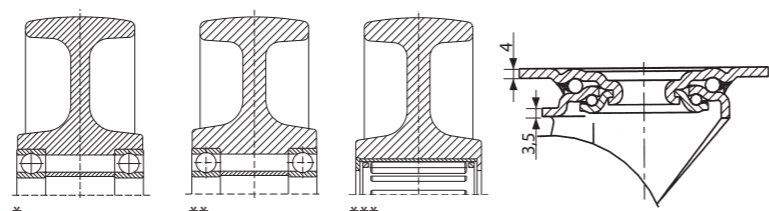
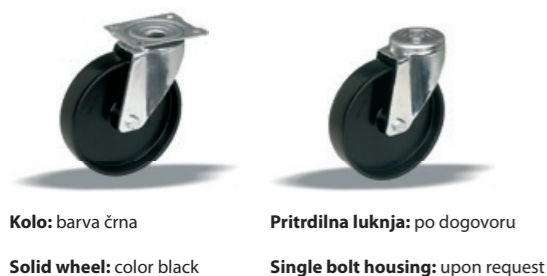

## KOLESA Z OJAČANIMI VILICAMI

OJAČANE CINKANE JEKLENE VILICE, DVOJNI KROGLIČNI LEŽAJ S TEKALIŠČI IZ POBOLJŠANEGA JEKLA, KOLO IZ POLIAMIDA (PA), ČRNE ALI NATUR BELE BARVE, DRŠNI LEŽAJ.

### REINFORCED SWIVEL AND FIXED CASTORS

ZINC ELECTRO-PLATED REINFORCED STEEL FORKS, DOUBLE BALL BEARING, HARDENED STEEL BALL RACES, POLYAMIDE (PA) SOLID WHEEL, BLACK OR NATURAL WHITE COLOUR, PLAIN BEARING.

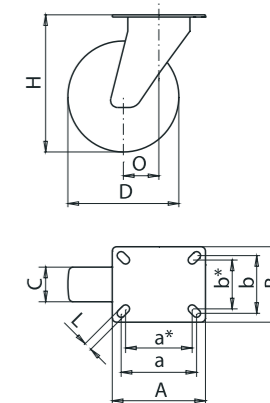
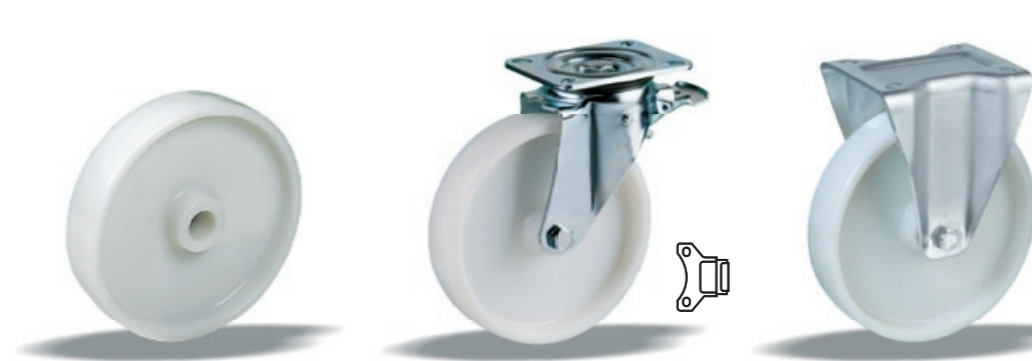

#### Kolesa brez vilic / Wheels

ident.	D mm	C mm	F mm	W mm	kg	kg
23705	160	44	20	59	0,65	400
23707	200	44	20	59	0,80	500
45133	200	44	20	59	0,82	750

#### Kolesa z gibljivimi vilicami / Swivel Castors

ident.	D mm	C mm	AxB mm	a/a*xb/b* mm	L mm	O mm	H mm	kg	kg
55380	160	44	135x110	110/100x85/75	11	54	200	2,45	400
56582	200	44	135x110	110/100x85/75	11	60	240	2,70	500

#### Kolesa z gibljivimi vilicami - zavora / Swivel Castors - Brake

ident.	D mm	C mm	AxB mm	a/a*xb/b* mm	L mm	O mm	H mm	kg	kg
42555	160	44	135x110	110/100x85/75	11	54	200	2,80	400
42573	200	44	135x110	110/100x85/75	11	60	240	3,05	500

#### Kolesa s stabilnimi vilicami / Fixed Castors

ident.	D mm	C mm	AxB mm	a/a*xb/b* mm	L mm	H mm	kg	kg
54621	160	44	135x110	110/100x85/75	11	200	1,80	400
56585	200	44	135x110	110/100x85/75	11	240	2,10	500

#### RAZLIČICE - DODATKI / VARIETIES - ACCESSORIES

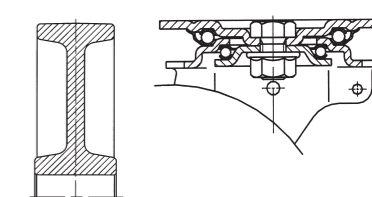





## KOLESA Z OJAČANIMI VILICAMI

OJAČANE CINKANE JEKLENE VILICE, DVOJNI KROGLIČNI LEŽAJ S TEKALIŠČI IZ POBOLJŠANEGA JEKLA, KOLO IZ POLIAMIDA (PA), NATUR BELE BARVE, KROGLIČNI LEŽAJ.

### REINFORCED SWIVEL AND FIXED CASTORS

ZINC ELECTRO-PLATED REINFORCED STEEL FORKS, DOUBLE BALL BEARING, HARDENED STEEL BALL RACES, POLYAMIDE (PA) SOLID WHEEL, NATURAL WHITE COLOUR, BALL BEARING.

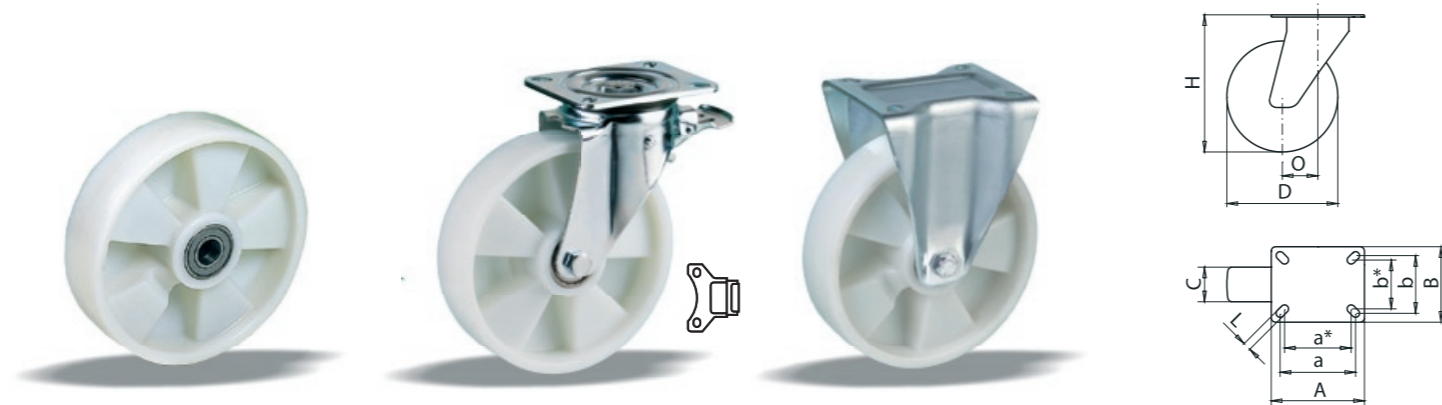

## KOLESA Z OJAČANIMI VILICAMI

OJAČANE CINKANE JEKLENE VILICE, PLATIŠČE IZ POLIAMIDA, POLIURETAN OBLOGA (93 ShA), KROGLIČNI, VALJČNI ALI DRSNI LEŽAJ.

### REINFORCED SWIVEL AND FIXED CASTORS

ZINC ELECTRO-PLATED REINFORCED STEEL FORKS, POLYAMIDE WHEEL CENTRE, POLYURETHANE TREAD (93 ShA), BALL BEARING, ROLLER BEARING OR PLAIN BEARING.



#### Kolesa brez vilic / Wheels

ident.	D mm	C mm	F mm	W mm	kg	kg
35595	160	50	20	60	0,60	400
35605	200	50	20	60	0,70	500
45812*	200	50	20	60	0,82	750

PA ojačan s steklenimi vlakni / Fiberglass reinforced polyamide

#### Kolesa z gibljivimi vilicami / Swivel Castors

ident.	D mm	C mm	AxB mm	a/a*xb/b*mm	L mm	O mm	H mm	kg	kg
31774	160	50	135x110	110/100x85/75	11	54	200	2,40	400
31793	200	50	135x110	110/100x85/75	11	60	240	2,60	500

#### Kolesa z gibljivimi vilicami - zavora / Swivel Castors - Brake

ident.	D mm	C mm	AxB mm	a/a*xb/b*mm	L mm	O mm	H mm	kg	kg
42563	160	50	135x110	110/100x85/75	11	54	200	2,75	400
42574	200	50	135x110	110/100x85/75	11	60	240	2,95	500

#### Kolesa s stabilnimi vilicami / Fixed Castors

ident.	D mm	C mm	AxB mm	a/a*xb/b*mm	L mm	H mm	kg	kg
31775	160	50	135x110	110/100x85/75	11	200	1,85	400
22830	200	50	135x110	110/100x85/75	11	240	2,00	500

#### RAZLIČICE - DODATKI / VARIETIES - ACCESSORIES



Zavora: smerna (stran 69)

Directional locking device (page 69)

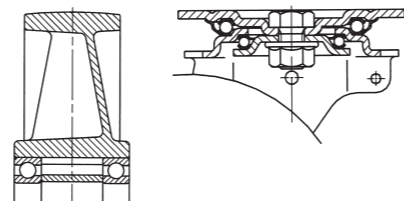

#### Kolesa z gibljivimi vilicami - priroba / Swivel Castors - Top Plate

ident.	ident.	D mm	C mm	AxB mm	a/a*xb/b* mm	L mm	O mm	H mm	kg	kg
41114	41134	100	32	105x85	85/75x65/55	9	40	131	0,92	150
41115	41135	100	32	105x85	85/75x65/55	9	40	131	0,87	150
41123	41143	100	32	105x85	85/75x65/55	9	40	131	0,83	150
41124	41144	125	32	105x85	85/75x65/55	9	40	158	1,04	200
41125	41145	125	32	105x85	85/75x65/55	9	40	158	0,99	200
41133	41153	125	32	105x85	85/75x65/55	9	40	158	0,95	200

#### Kolesa s stabilnimi vilicami / Fixed Castors

ident.	D mm	C mm	AxB mm	a/a*xb/b* mm	L mm	H mm	kg	kg
41094	100	32	105x85	85/75x65/55	9	131	0,57	150
41095	100	32	105x85	85/75x65/55	9	133	0,52	150
41103	100	32	105x85	85/75x65/55	9	131	0,48	150
41104	125	32	105x85	85/75x65/55	9	158	0,60	200
41105	125	32	105x85	85/75x65/55	9	158	0,64	200
41113	125	32	105x85	85/75x65/55	9	158	0,69	200

#### RAZLIČICE - DODATKI / VARIETIES - ACCESSORIES



Kovinski pokrov: velik

Metal treadguard: big



Pritrdilna luknja: po dogovoru

Single bolt housing: upon request

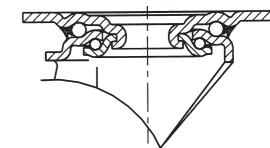



## KOLESA Z OJAČANIMI VILICAMI

OJAČANE CINKANE JEKLENE VILICE, DVOJNI KROGLIČNI LEŽAJ S TEKALIŠČI IZ POBOLJŠANEGA JEKLA, PLATIŠČE IZ POLIAMIDA, POLIURETAN OBLOGA (93 SHa), KROGLIČNI, VALJČNI ALI DRSNI LEŽAJ.

## REINFORCED SWIVEL AND FIXED CASTORS

ZINC ELECTRO-PLATED REINFORCED STEEL FORKS, DOUBLE BALL BEARING, HARDENED STEEL BALL RACES, POLYAMID WHEEL CENTRE, POLYURETHANE TREAD (93 SHa), BALL BEARING, ROLLER BEARING OR PLAIN BEARING.

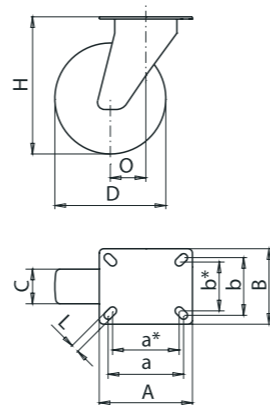

## KOLESA

PLATIŠČE IZ ALUMINIJA, NALITA GUMA-ELASTIK (65 SHa) ALI POLIURETAN (92 SHa), KROGLIČNI LEŽAJ.

## WHEELS

ALUMINIUM WHEEL CENTRE, SOFT ELASTIC RUBBER (65 SHa) OR POLYURETHANE TREAD (92 SHa), BALL BEARING.

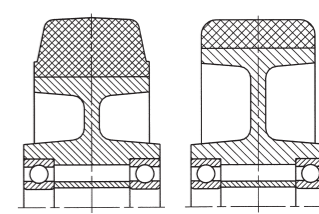

### Kolesa z gibljivimi vilicami / Swivel Castors

ident.	D mm	C mm		AxB mm	a/a*xb/b* mm	L mm	O mm	H mm	kg	kg
42474	160	50	●●	135x110	110/100x85/75	11	54	200	2,50	400
42584	160	50	■	135x110	110/100x85/75	11	54	200	2,40	400
42585	160	50	■	135x110	110/100x85/75	11	54	200	2,30	400
42593	200	50	●●	135x110	110/100x85/75	11	60	240	3,00	500
42594	200	50	■	135x110	110/100x85/75	11	60	240	2,90	500
42595	200	50	■	135x110	110/100x85/75	11	60	240	2,85	500

### Kolesa z gibljivimi vilicami - zavora / Swivel Castors - Brake

ident.	D mm	C mm		AxB mm	a/a*xb/b* mm	L mm	O mm	H mm	kg	kg
42475	160	50	●●	135x110	110/100x85/75	11	54	200	2,80	400
42603	160	50	■	135x110	110/100x85/75	11	54	200	2,75	400
42604	160	50	■	135x110	110/100x85/75	11	54	200	2,65	400
42605	200	50	●●	135x110	110/100x85/75	11	60	240	3,35	500
42613	200	50	■	135x110	110/100x85/75	11	60	240	3,25	500
42614	200	50	■	135x110	110/100x85/75	11	60	240	3,20	500

### Kolesa s stabilnimi vilicami / Fixed Castors

ident.	D mm	C mm		AxB mm	a/a*xb/b* mm	L mm	H mm	kg	kg
42615	160	50	●●	135x110	110/100x85/75	11	200	1,90	400
42623	160	50	■	135x110	110/100x85/75	11	200	1,85	400
42624	160	50	■	135x110	110/100x85/75	11	200	1,75	400
42625	200	50	●●	135x110	110/100x85/75	11	240	2,45	500
42633	200	50	■	135x110	110/100x85/75	11	240	2,35	500
42634	200	50	■	135x110	110/100x85/75	11	240	2,30	500

### RAZLIČICE - DODATKI / VARIETIES - ACCESSORIES



Zavora: smerna (stran 69)

Directional locking device (page 69)

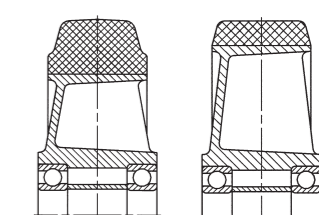
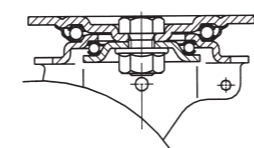

ident.	ident.	D mm	C mm		F mm	W mm	kg	kg
42495		100	40	●●	12	44	0,50	170
	42344	100	40	●●	12	44	0,45	250
42343		125	40	●●	12	44	0,55	200
	42345	125	40	●●	12	44	0,50	300

ident.	ident.	D mm	C mm		F mm	W mm	kg	kg
42514		160	50	●●	20	60	1,30	400
	17840	160	50	●●	20	60	1,20	600
42515		200	50	●●	20	60	1,75	500
	32894	200	50	●●	20	60	1,50	800
43504		250	50	●●	20	60	1,90	550
	46779	250	50	●●	20	60	1,80	800





## KOLESA Z OJAČANIMI VILICAMI

OJAČANE CINKANE JEKLENE VILICE, PLATIŠČE IZ ALUMINIJA, NALITA GUMA - ELASTIK (65 ShA) ALI POLIURETAN (92 ShA), KROGLIČNI LEŽAJ.

### REINFORCED SWIVEL AND FIXED CASTORS

ZINC ELECTRO-PLATED REINFORCED STEEL FORKS, ALUMINIUM WHEEL CENTRE, SOFT ELASTIC RUBBER (65 ShA) OR POLYURETHANE TREAD (92 ShA), BALL BEARING.

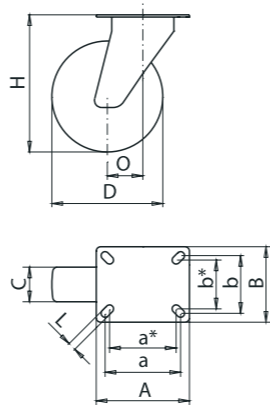

## KOLESA Z OJAČANIMI VILICAMI

OJAČANE CINKANE JEKLENE VILICE, DVOJNI KROGLIČNI LEŽAJ S TEKALŠČI IZ POBOLJŠANEGA JEKLA, PLATIŠČE IZ ALUMINIJA, NALITA GUMA - ELASTIK (65 ShA) ALI POLIURETAN (92 ShA), KROGLIČNI LEŽAJ.

### REINFORCED SWIVEL AND FIXED CASTORS

ZINC ELECTRO-PLATED REINFORCED STEEL FORKS, DOUBLE BALL BEARING, HARDENED STEEL BALL RACES, ALUMINIUM WHEEL CENTRE, SOFT ELASTIC RUBBER (65 ShA) OR POLYURETHANE TREAD (92 ShA), BALL BEARING.

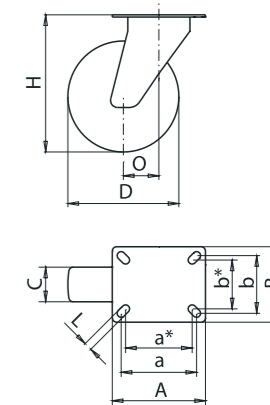
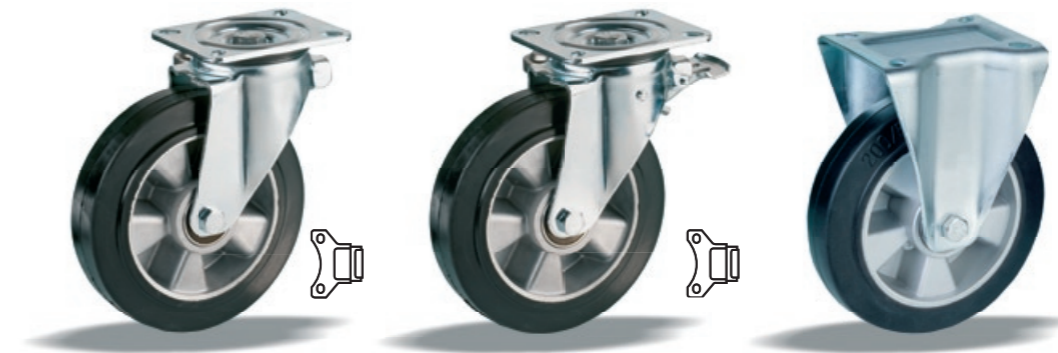

#### Kolesa z gibljivimi vilicami / Swivel Castors

ident.	ident.	D mm	C mm	Icons	AxB mm	a/a*xb/b* mm	L mm	O mm	H mm	kg	kg
42535		100	40	Icons	105x85	85/75x65/55	9	40	131	1,25	170
	42394	100	40	Icons	105x85	85/75x65/55	9	40	131	1,20	250
42363		125	40	Icons	105x85	85/75x65/55	9	40	158	1,30	200
	42395	125	40	Icons	105x85	85/75x65/55	9	40	158	1,25	300

#### Kolesa z gibljivimi vilicami / Swivel Castors

ident.	ident.	D mm	C mm	Icons	AxB mm	a/a*xb/b* mm	L mm	O mm	H mm	kg	kg
42364		160	50	Icons	135x110	110/100x85/75	11	54	200	3,00	400
	42403	160	50	Icons	135x110	110/100x85/75	11	54	200	2,90	600
42365		200	50	Icons	135x110	110/100x85/75	11	60	240	3,65	500
	42404	200	50	Icons	135x110	110/100x85/75	11	60	240	3,50	800
43841		250	50	Icons	135x110	110/100x85/75	11	68	289	4,25	550
	46781	250	50	Icons	135x110	110/100x85/75	11	68	289	4,25	650

#### Kolesa z gibljivimi vilicami - zavora / Swivel Castors - Brake

ident.	ident.	D mm	C mm	Icons	AxB mm	a/a*xb/b* mm	L mm	O mm	H mm	kg	kg
42543		100	40	Icons	105x85	85/75x65/55	9	40	131	1,35	170
	42405	100	40	Icons	105x85	85/75x65/55	9	40	131	1,30	250
42373		125	40	Icons	105x85	85/75x65/55	9	40	158	1,40	200
	42413	125	40	Icons	105x85	85/75x65/55	9	40	158	1,35	300

#### Kolesa z gibljivimi vilicami - zavora / Swivel Castors - Brake

ident.	ident.	D mm	C mm	Icons	AxB mm	a/a*xb/b* mm	L mm	O mm	H mm	kg	kg
42374		160	50	Icons	135x110	110/100x85/75	11	54	200	3,35	400
	42414	160	50	Icons	135x110	110/100x85/75	11	54	200	3,25	600
42375		200	50	Icons	135x110	110/100x85/75	11	60	240	4,00	500
	42415	200	50	Icons	135x110	110/100x85/75	11	60	240	3,85	800
43840		250	50	Icons	135x110	110/100x85/75	11	68	289	4,60	550
	46782	250	50	Icons	135x110	110/100x85/75	11	68	289	4,60	650

#### Kolesa s stabilnimi vilicami / Fixed Castors

ident.	ident.	D mm	C mm	Icons	AxB mm	a/a*xb/b* mm	L mm	H mm	kg	kg
42544		100	40	Icons	105x85	85/75x65/55	9	131	1,00	170
	42383	100	40	Icons	105x85	85/75x65/55	9	131	0,95	250
42353		125	40	Icons	105x85	85/75x65/55	9	158	1,05	200
	42384	125	40	Icons	105x85	85/75x65/55	9	158	1,00	300

#### Kolesa s stabilnimi vilicami / Fixed Castors

ident.	ident.	D mm	C mm	Icons	AxB mm	a/a*xb/b* mm	L mm	H mm	kg	kg
42354		160	50	Icons	135x110	110/100x85/75	11	200	2,45	400
	42385	160	50	Icons	135x110	110/100x85/75	11	200	2,35	600
42355		200	50	Icons	135x110	110/100x85/75	11	240	3,10	500
	42393	200	50	Icons	135x110	110/100x85/75	11	240	2,95	800
43494		250	50	Icons	135x110	110/100x85/75	11	289	3,75	550
	46780	250	50	Icons	135x110	110/100x85/75	11	289	3,75	650

#### RAZLIČICE - DODATKI / VARIETIES - ACCESSORIES



Obloga: poliuretan  
Tread: polyurethane

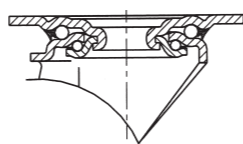

#### RAZLIČICE - DODATKI / VARIETIES - ACCESSORIES



Obloga: poliuretan  
Tread: polyurethane



Zavora: smerna (stran 69)  
Directional locking device (page 69)

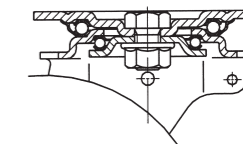



### KOLESA

PLATIŠČE IZ SIVE LITINE, NALITA GUMA-ELASTIK (65 ShA) ALI POLIURETAN (92 ShA), KOLO IZ SIVE LITINE, KROGLIČNI LEŽAJ.

### WHEELS

CAST IRON WHEEL CENTRE, ELASTIC SOFT RUBBER (65 ShA) OR POLYURETHANE TREAD (92 ShA), CAST IRON SOLID WHEEL, BALL BEARING.



### KOLESA Z OJAČANIMI VILICAMI

OJAČANE CINKANE JEKLENE VILICE, DVOJNI KROGLIČNI LEŽAJ S TEKALIŠČI IZ POBOLJŠANEGA JEKLA, PLATIŠČE IZ SIVE LITINE, LAKIRANO, NALITA GUMA (65 ShA) ALI POLIURETAN (92 ShA), KROGLIČNI LEŽAJ.

### REINFORCED SWIVEL AND FIXED CASTORS

ZINC ELECTRO-PLATED REINFORCED STEEL FORKS, DOUBLE BALL BEARING, HARDENED STEEL BALL RACES, CAST IRON WHEEL CENTRE, LACQUERED, ELASTIC SOFT RUBBER (65 ShA) OR POLYURETHANE (92 ShA) TREAD, BALL BEARING.

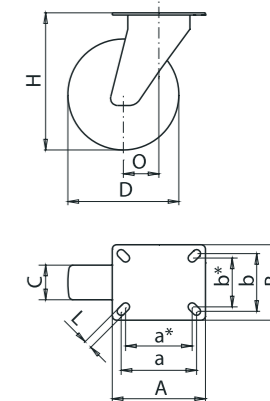
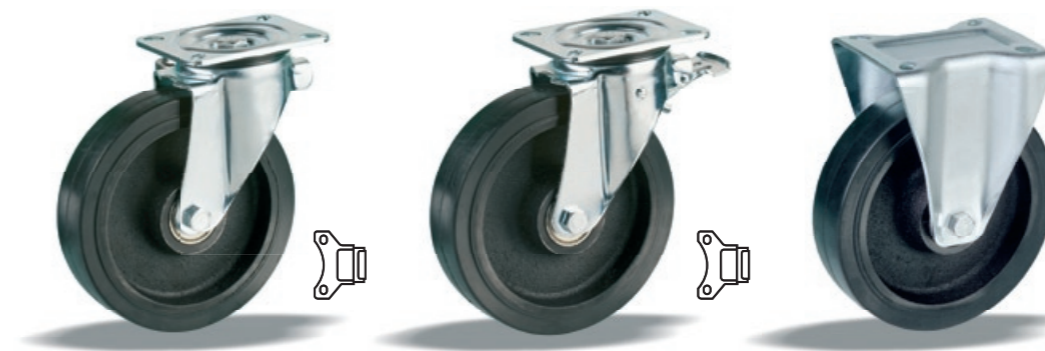

#### Kolesa z gibljivimi vilicami / Swivel Castors

ident.	ident.	ident.	D mm	C mm	F mm	W mm	kg	kg
42505			160	50	20	60	3,00	500
	42503		160	50	20	60	3,05	850
	35543*		160	50	20	60	3,05	850
		35554	160	50	20	60	2,85	900
42513			200	50	20	60	4,35	600
	35553*		200	50	20	60	4,40	1000
	42504		200	50	20	60	4,40	1000
		35555	200	50	20	60	4,65	1100

ident.	ident.	ident.	D mm	C mm	AxB mm	a/a*xb/b* mm	L mm	O mm	H mm	kg	kg
42425			160	50	135x110	110/100x85/75	11	54	200	4,80	500
	42445		160	50	135x110	110/100x85/75	11	54	200	4,85	850
		56392	160	50	135x110	110/100x85/75	11	54	200	4,65	900
42433			200	50	135x110	110/100x85/75	11	60	240	6,25	600
	42453		200	50	135x110	110/100x85/75	11	60	240	6,30	1000
		55391	200	50	135x110	110/100x85/75	11	60	240	6,55	1000

#### Kolesa z gibljivimi vilicami - zavora / Swivel Castors - Brake

ident.	ident.	ident.	D mm	C mm	AxB mm	a/a*xb/b* mm	L mm	O mm	H mm	kg	kg
42434			160	50	135x110	110/100x85/75	11	54	200	5,15	500
	42454		160	50	135x110	110/100x85/75	11	54	200	5,20	850
		42525	160	50	135x110	110/100x85/75	11	54	200	5,00	900
42435			200	50	135x110	110/100x85/75	11	60	240	6,60	600
	42455		200	50	135x110	110/100x85/75	11	60	240	6,65	1000
		42533	200	50	135x110	110/100x85/75	11	60	240	6,90	1000

#### Kolesa s stabilnimi vilicami / Fixed Castors

ident.	ident.	ident.	D mm	C mm	AxB mm	a/a*xb/b* mm	L mm	H mm	kg	kg
42423			160	50	135x110	110/100x85/75	11	200	4,25	500
	42443		160	50	135x110	110/100x85/75	11	200	4,30	850
		56394	160	50	135x110	110/100x85/75	11	200	4,10	900
42424			200	50	135x110	110/100x85/75	11	240	5,70	600
	42444		200	50	135x110	110/100x85/75	11	240	5,75	1000
		56395	200	50	135x110	110/100x85/75	11	240	6,00	1000

#### RAZLIČICE - DODATKI / VARIETIES - ACCESSORIES

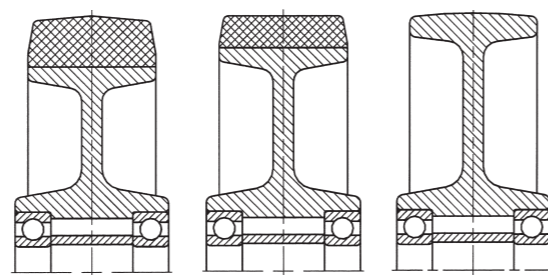

#### RAZLIČICE - DODATKI / VARIETIES - ACCESSORIES



Obloga: poliuretan  
Tread: polyurethane

Obloga: brez  
Tread: Solid wheel

Zavora: smerna (stran 69)  
Directional locking device (page 69)

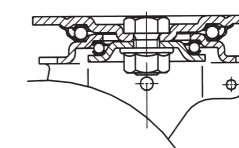





## KOLESA Z LITOŽELEZNIMI VILICAMI

VILICE IN PRIROBA IZ TEMPRANE LITINE, KROGLIČNI LEŽAJ, PLATIŠČE IZ SIVE LITINE, LAKIRANO, NALITA GUMA (65 ShA) ALI POLIURETAN (92 ShA), KROGLIČNI LEŽAJ.

## CAST IRON SWIVEL AND FIXED CASTORS

FORK AND TOP-PLATE FROM MALLEABLE CAST IRON, BALL BEARING, WHEEL CENTRE FROM GRAY CAST IRON, LACQUERED, RUBBER (65 ShA) OR POLYURETHANE (92 ShA) TREAD, BALL BEARING.

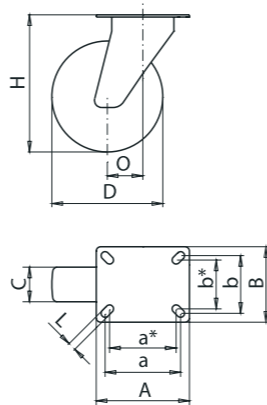

## ZAVORA GIBLJIVIH VILIC

CINKAN JEKLEN MEHANIZEM, VZMET IZ NERJAVEČEGA JEKLA.

## DIRECTIONAL LOCKING DEVICE

ZINC ELECTRO-PLATED STEEL MECHANISM, STAINLESS STEEL SPRING.



### Kolesa z gibljivimi vilicami / Swivel Castors

ident.	ident.	ident.	D mm	C mm		AxB mm	a/a*xb/b* mm	L mm	O mm	H mm	kg	kg
55383			160	50		133x108	105x80	11	50	205	5,60	500
	60999		160	50		133x108	105x80	11	50	205	5,65	850
		56198	160	50		133x108	105x80	11	50	205	5,45	900
55388			200	50		133x108	105x80	11	55	245	7,15	600
	61003		200	50		133x108	105x80	11	55	245	7,20	1000
		56200	200	50		133x108	105x80	11	55	245	7,45	1100

ident.	mm	mm	mm
43625	80	11	68
42953	80	11	88
43931	105	11	81
43932	105	11	101

### Kolesa s stabilnimi vilicami / Fixed Castors

ident.	ident.	ident.	D mm	C mm		AxB mm	a/a*xb/b* mm	L mm	H mm	kg	kg
54623			160	50		133x108	105x80	11	205	4,90	500
	61000		160	50		133x108	105x80	11	205	4,95	850
		56199	160	50		133x108	105x80	11	205	4,75	900
55372			200	50		133x108	105x80	11	245	6,45	600
	61004		200	50		133x108	105x80	11	245	6,50	1000
		56209	200	50		133x108	105x80	11	245	6,75	1100

### RAZLIČICE - DODATKI / VARIETIES - ACCESSORIES



**Obloga:** guma  
**Tread:** rubber

**Obloga:** poliuretan  
**Tread:** polyurethane

**Obloga:** brez  
**Tread:** Solid wheel

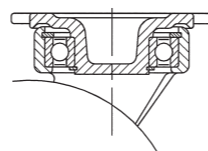



**KOLESA  
ZA NERAVNA  
TLA**



**CASTORS  
AND WHEELS  
FOR ROUGH  
FLOORS**





## KOLESA Z VILICAMI

CINKANE JEKLENE VILICE, PLATIŠČE IZ POLIPROPILENA, PNEVMATIKA 200x50 2 PR, VALJČNI ALI DRSNI LEŽAJ.

### SWIVEL AND FIXED CASTORS

ZINC ELECTRO-PLATED STEEL FORKS, POLYPROPYLENE WHEEL CENTRE, PNEUMATIC TYRE 200x50 2 PR, ROLLER BEARING OR PLAIN BEARING.

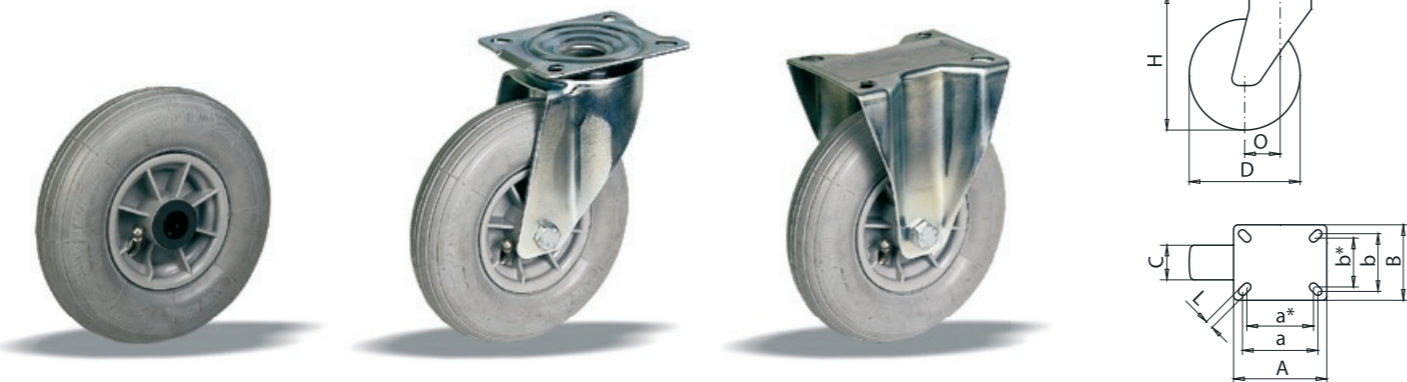

## KOLESA Z VILICAMI

CINKANE JEKLENE VILICE IN PLATIŠČE, PNEVMATIKA 200x50 2 PR, VALJČNI ALI DRSNI LEŽAJ.

### SWIVEL AND FIXED CASTORS

ZINC ELECTRO-PLATED STEEL FORKS AND WHEEL CENTRE, PNEUMATIC TYRE 200x50 2 PR, ROLLER BEARING OR PLAIN BEARING.

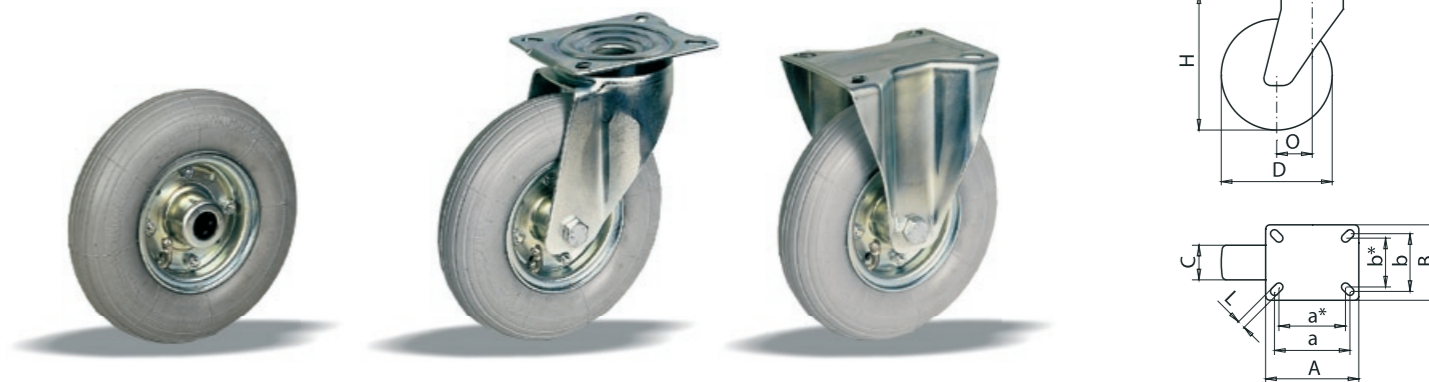

#### Kolesa brez vilic / Wheels

ident.	D mm	C mm	F mm	W mm	kg	kg
64097	~200	~50	20	58	0,43	60
64100	~200	~50	20	58	0,37	60

#### Kolesa brez vilic / Wheels

ident.	D mm	C mm	F mm	W mm	kg	kg
62097	~200	~50	20	58	0,75	75
91044	~200	~50	20	58	0,60	75

#### Kolesa z gibljivimi vilicami - priroba / Swivel Castors - Top Plate

ident.	D mm	C mm	AxB mm	a/a*x/b/b* mm	L mm	O mm	H mm	kg	kg
32645	~200	~50	135x110	110/100x85x75	11	60	232	1,70	60
32664	~200	~50	135x110	110/100x85x75	11	60	232	1,63	60

#### Kolesa z gibljivimi vilicami - priroba / Swivel Castors - Top Plate

ident.	D mm	C mm	AxB mm	a/a*x/b/b* mm	L mm	O mm	H mm	kg	kg
62098	~200	~50	135x110	110/100x85x75	11	60	232	2,05	75
31833	~200	~50	135x110	110/100x85x75	11	60	232	1,90	75

#### Kolesa s stabilnimi vilicami / Fixed Castors

ident.	D mm	C mm	AxB mm	a/a*x/b/b* mm	L mm	H mm	kg	kg
32693	~200	~50	135x110	110/100x85x75	11	232	1,32	60
32703	~200	~50	135x110	110/100x85x75	11	232	1,26	60

#### Kolesa s stabilnimi vilicami / Fixed Castors

ident.	D mm	C mm	AxB mm	a/a*x/b/b* mm	L mm	H mm	kg	kg
62099	~200	~50	135x110	110/100x85x75	11	232	1,65	75
31834	~200	~50	135x110	110/100x85x75	11	232	1,50	75

#### RAZLIČICE - DODATKI / VARIETIES - ACCESSORIES

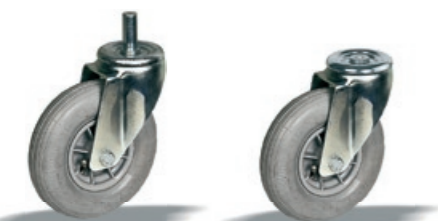

Pritrdilni čep: po dogovoru Pritrdilna luknja: po dogovoru  
Stem housing: upon request Single bolt housing: upon request

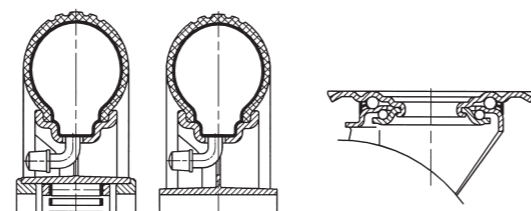

#### RAZLIČICE - DODATKI / VARIETIES - ACCESSORIES



Pritrdilni čep: po dogovoru Pritrdilna luknja: po dogovoru  
Stem housing: upon request Single bolt housing: upon request

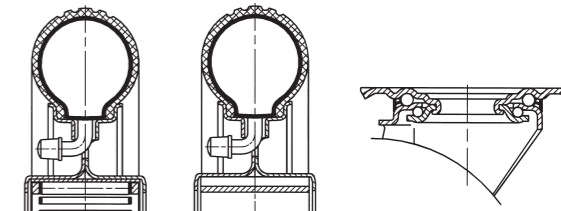



## KOLESA Z VILICAMI

CINKANE JEKLENE VILICE, PLATIŠČE IZ POLIPROPILENA, PNEVMATIKA, VALJČNI ALI DRJNI LEŽAJ.

### SWIVEL AND FIXED CASTORS

ZINC ELECTRO-PLATED STEEL FORKS, POLYPROPYLENE WHEEL CENTRE, PNEUMATIC TYRE, ROLLER BEARING OR PLAIN BEARING.

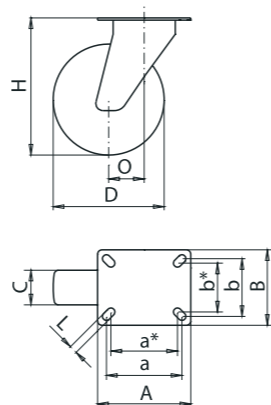

#### Kolesa brez vilic / Wheels

ident.	D mm	C mm		F mm	W mm	kg	kg
* 91070	~220	~65	≡	20	75	0,90	150
* 91072	~220	~65	≡	20	75	0,80	150
** 64102	~260	~85	≡	20	75	1,00	150
** 64107	~260	~85	≡	20	75	0,90	150

#### Kolesa z gibljivimi vilicami / Swivel Castors

ident.	D mm	C mm		AxB mm	a/a*xb/b* mm	L mm	O mm	H mm	kg	kg
* 31845	~220	~65	≡	175x140	145/135x110/100	11	65	255	3,30	150
* 31853	~220	~65	≡	175x140	145/135x110/100	11	65	255	3,25	150
** 91122	~260	~85	≡	175x140	145/135x110/100	11	70	290	3,65	150
** 91123	~260	~85	≡	175x140	145/135x110/100	11	70	290	3,50	150

#### Kolesa s stabilnimi vilicami / Fixed Castors

ident.	D mm	C mm		AxB mm	a/a*xb/b* mm	L mm	H mm	kg	kg
* 31854	~220	~65	≡	175x140	145/135x110/100	11	255	2,65	150
* 31855	~220	~65	≡	175x140	145/135x110/100	11	255	2,60	150
** 91124	~260	~85	≡	175x140	145/135x110/100	11	290	2,95	150
** 91125	~260	~85	≡	175x140	145/135x110/100	11	290	2,80	150

#### RAZLIČICE - DODATKI / VARIETIES - ACCESSORIES



**Pokrov:** ident 65022  
\* Pnevmatika 2,50-4 2PR  
\*\* Pnevmatika 3,00-4 2PR

**Treadguard:** ident 65022  
\* Pneumatic tyre 2,50-4 2PR  
\*\* Pneumatic tyre 3,00-4 2PR

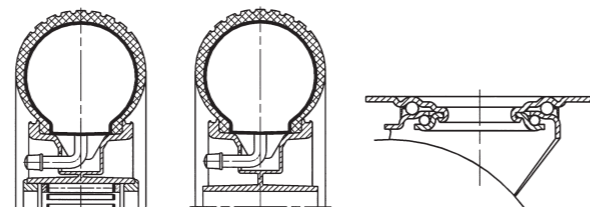

## KOLESA Z VILICAMI

CINKANE JEKLENE VILICE IN PLATIŠČE, PNEVMATIKA, VALJČNI LEŽAJ.

### SWIVEL AND FIXED CASTORS

ZINC ELECTRO-PLATED STEEL FORKS AND WHEEL CENTRE, PNEUMATIC TYRE, ROLLER BEARING.

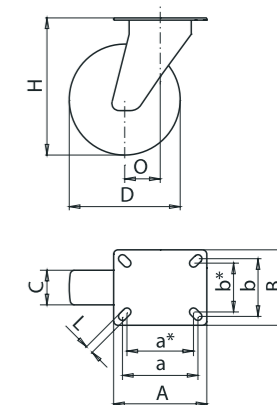

#### Kolesa brez vilic / Wheels

ident.	D mm	C mm		F mm	W mm	kg	kg
* 31864	~220	~65	≡	20	75	1,40	200
** 91045	~260	~85	≡	20	75	1,50	200

#### Kolesa z gibljivimi vilicami / Swivel Castors

ident.	D mm	C mm		AxB mm	a/a*xb/b* mm	L mm	O mm	H mm	kg	kg
* 31865	~220	~65	≡	175x140	145/135x110/100	11	65	255	4,00	200
** 30174	~260	~85	≡	175x140	145/135x110/100	11	70	290	4,20	200

#### Kolesa s stabilnimi vilicami / Fixed Castors

ident.	D mm	C mm		AxB mm	a/a*xb/b* mm	L mm	H mm	kg	kg
* 31873	~220	~65	≡	175x140	145/135x110/100	11	255	3,30	200
** 30175	~260	~85	≡	175x140	145/135x110/100	11	290	3,50	200

#### RAZLIČICE - DODATKI / VARIETIES - ACCESSORIES



\* Pnevmatika 2,50-4 4PR  
\*\* Pnevmatika 3,00-4 4PR

\* Pneumatic tyre 2,50-4 4PR  
\*\* Pneumatic tyre 3,00-4 4PR

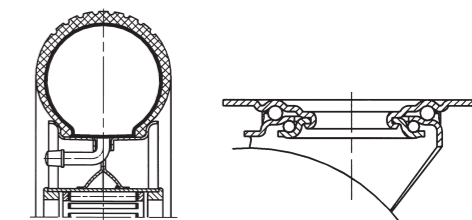





## KOLESA Z VARJENIMI VILICAMI

VARJENE, LAKIRANE VILICE, LAKIRANO PESTO IZ SIVE LITINE, CINKANO JEKLENO PLATIŠČE, GUMI OBROČ ALI PNEVMATIKA, KROGLIČNI LEŽAJ.

### WELDED SWIVEL AND FIXED CASTORS

LACQUERED WELDED FORKS AND CAST IRON HUB, ZINC ELECTRO-PLATED STEELWHEEL CENTRE, RUBBER TYRE OR PNEUMATIC TYRE, BALL BEARING.

## KOLESA

CINKANO JEKLENO PLATIŠČE, PNEVMATIKA 4,00-6 2 PR, KROGLIČNI ALI DRSNI LEŽAJ.

### WHEELS

ZINC ELECTRO-PLATED STEEL WHEEL CENTRE, PNEUMATIC TYRE 4,00-6 2 PR, BALL BEARING OR PLAIN BEARING.

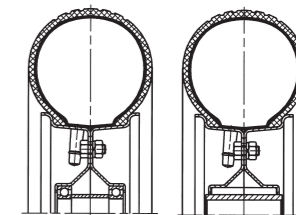

#### Kolesa brez vilic / Wheels

ident.	D mm	C mm	F mm	W mm	kg	kg	ident.	D mm	C mm	F mm	W mm	kg	kg
22899*	350	100	56	56	9,50	300	57806	~350	~100	25	56	2,60	150
22898**	~350	~100	25	56	4,10	300	28226	~350	~100	25	67	2,55	150

#### Kolesa z gibljivimi vilicami / Swivel Castors

ident.	D mm	C mm	AxB mm	axb mm	L mm	O mm	H mm	kg	kg
22950*	350	100	190x120	150x75	13	90	450	14,30	300
31361**	~350	~100	190x120	150x75	13	90	450	13,40	300

#### Kolesa s stabilnimi vilicami / Fixed Castors

ident.	D mm	C mm	AxB mm	axb mm	L mm	H mm	kg	kg
22827*	350	100	190x120	150x75	13	450	14,00	300
31362**	~350	~100	190x120	150x75	13	450	8,55	300

#### RAZLIČICE - DODATKI / VARIETIES - ACCESSORIES



\* Gumi obroč  
\*\* Pnevmatika 4,00-6 4PR

\* Rubber tyre  
\*\* Pneumatic tyre 4,00-6 4PR

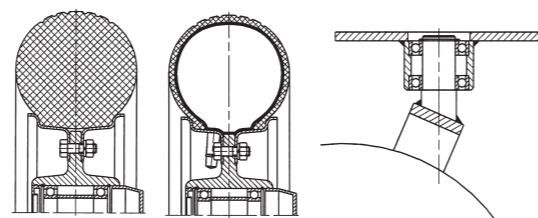







**KOLESA  
ZA USTANOVE**

**INSTITUTIONAL  
CASTORS  
AND WHEELS**





### KOLESA Z GIBLJIVIMI ALI STABILNIMI VILICAMI

CINKANE JEKLENE VILICE, POLIPROPILENSKO PLATIŠČE, TERMOPLASTIČNA GUMI OBLOGA (82 ShA), KROGLIČNI LEŽAJ.

### SWIVEL OR FIXED CASTORS

ZINC ELECTRO-PLATED STEEL FORKS, POLYPROPYLENE WHEEL CENTRE, THERMOPLASTIC RUBBER TREAD (82 ShA), BALL BEARING.



### KOLESA Z GIBLJIVIMI ALI STABILNIMI VILICAMI - PRITRDILNA LUKNJA

CINKANE JEKLENE VILICE, POLIPROPILENSKO PLATIŠČE, TERMOPLASTIČNA GUMI OBLOGA (82 ShA), KROGLIČNI LEŽAJ.

### SWIVEL OR FIXED CASTORS - SINGLE BOLT HOUSING

ZINC ELECTRO-PLATED STEEL FORKS, POLYPROPYLENE WHEEL CENTRE, THERMOPLASTIC RUBBER TREAD (82 ShA), BALL BEARING.



Ident	D mm	C mm	F mm	W mm	kg	kg
44810	75	24	8	28	0,09	60
44811	100	24	8	28	0,12	70
44812	100	32	10	36	0,19	90
44813	125	32	10	36	0,23	100
44814	150	32	10	36	0,30	100

Koda	D mm	C mm	L mm	B mm	O mm	H mm	kg	kg
44830	75	24	10.2	50	30.5	101	0,29	60
44831	100	24	10.2	50	40	123.5	0,37	70
44832	100	32	12.2	60	40	131.5	0,56	90
44833	125	32	12.2	60	40	156.5	0,70	100
44834	150	32	12.2	60	40	181.5	0,85	100

Ident	D mm	C mm	A x B mm	a/a* x b/b* mm	L mm	O mm	H mm	kg	kg
44815	75	24	60 x 60	43/49 x 43/49	6.4	30.5	101	0,32	60
44816	100	24	60 x 60	43/49 x 43/49	6.4	40	123.5	0,40	70
44817	100	32	90 x 70	65/78 x 45/55	9	40	131.5	0,64	90
44818	125	32	90 x 70	65/78 x 45/55	9	40	156.5	0,77	100
44819	150	32	90 x 70	65/78 x 45/55	9	45	181.5	0,93	100

Ident	D mm	C mm	L mm	B mm	O mm	H mm	kg	kg
44835	75	24	10.2	50	30.5	101	0,33	60
44836	100	24	10.2	50	40	123.5	0,41	70
44837	100	32	12.2	60	40	131.5	0,63	90
44838	125	32	12.2	60	40	156.5	0,76	100
44839	150	32	12.2	60	45	181.5	0,91	100

Ident	D mm	C mm	A x B mm	a/a* x b/b* mm	L mm	O mm	H mm	kg	kg
44820	75	24	60 x 60	43/49 x 43/49	6.4	30.5	101	0,36	60
44821	100	24	60 x 60	43/49 x 43/49	6.4	40	123.5	0,44	70
44822	100	32	90 x 70	65/78 x 45/55	9	40	131.5	0,71	90
44823	125	32	90 x 70	65/78 x 45/55	9	40	156.5	0,84	100
44824	150	32	90 x 70	65/78 x 45/55	9	45	181.5	0,99	100

Ident	D mm	C mm	L mm	H mm	kg	kg
44840	75	24	10.2	101	0,21	60
44841	100	24	10.2	123.5	0,27	70
44842	100	32	12.2	131.5	0,44	90
44843	125	32	12.2	156.5	0,56	100
44844	150	32	12.2	181.5	0,70	100

Ident	D mm	C mm	A x B mm	a/a* x b/b* mm	L mm	H mm	kg	kg
44825	75	24	60 x 60	43/49 x 43/49	6.4	101	0,25	60
44826	100	24	60 x 60	43/49 x 43/49	6.4	123.5	0,32	70
44827	100	32	90 x 70	65/78 x 45/55	9	131.5	0,54	90
44828	125	32	90 x 70	65/78 x 45/55	9	156.5	0,66	100
44829	150	32	90 x 70	65/78 x 45/55	9	181.5	0,80	100

### OSTALE POVRŠINSKE ZAŠČITE MATERIALA / OTHER SURFACE COATINGS MATERIALS



Elektrostatično prašno lakiranje / Electrostatic powder coating  
Obsežna paleta barv / Big palette of colours

Niklanje / Nickel plating

Kromanje / Chrome plating  
Nerjavno jeklo / Stainless steel





### KOLESA Z GIBLJIVIMI ALI STABILNIMI VILICAMI - RAZPORNNA PUŠA

CINKANE JEKLENE VILICE, POLIPROPILENSKO PLATIŠČE, TERMOPLASTIČNA GUMI OBLOGA (82 ShA), KROGLIČNI LEŽAJ.

### SWIVEL OR FIXED CASTORS - PLASTIC EXPANDER FITTING

ZINC ELECTRO-PLATED STEEL FORKS, POLYPROPYLENE WHEEL CENTRE, THERMOPLASTIC RUBBER TREAD (82 ShA), BALL BEARING.



### KOLESA Z GIBLJIVIMI VILICAMI

CINKANE JEKLENE VILICE, PLATIŠČE IZ POLIPROPILENA, POLITEILENSKA ALI GUMI OBLOGA, DRSNI ALI KROGLIČNI LEŽAJ.

### SWIVEL CASTORS

ZINC ELECTRO-PLATED STEEL WHEEL CENTRE, POLYPROPYLENE WHEEL CENTRE, POLYETHYLENE OR THERMOPLASTIC RUBBER TREAD, PLAIN BEARING OR BALL BEARING.



#### Kolesa brez vilic / Wheels

Ident	D mm	C mm	GLEJ SPODAJ / SEE BELOW	B mm	O mm	H mm	kg	kg	ident.	ident.	D mm	C mm	F mm	W mm	kg	kg
44830	75	24	☐	50	30.5	101	0,36	60	44803	33683	75	25	8	27,5	0,06	55
44831	100	24	☐	50	40	123,5	0,44	70	44804		100	30	8,3	36	0,23	85
44832	100	32	☐	60	40	131,5	0,63	90			125	32	8,3	36	0,40	100
44833	125	32	☐	60	40	156,5	0,76	100								
44834	150	32	☐	60	40	181,5	0,92	100								

#### Kolesa z gibljivimi vilicami / Swivel Castors

Ident	D mm	C mm	GLEJ SPODAJ / SEE BELOW	B mm	O mm	H mm	kg	kg	ident.	ident.	D mm	C mm	L mm	O mm	H mm	kg	kg
44835	75	24	☐	50	30.5	101	0,40	60	44889	35374	75	25	10	30	100	0,30	55
44836	100	24	☐	50	40	123,5	0,48	70	44809		100	30	12	35	130	0,60	85
44837	100	32	☐	60	40	131,5	0,70	90			125	32	12	38	155	0,85	100
44838	125	32	☐	60	40	156,5	0,83	100									
44839	150	32	☐	60	45	181,5	0,98	100									

#### Zaščitni obroč / Protective ring

Ident	D mm	C mm	GLEJ SPODAJ / SEE BELOW	H mm	kg	kg	ident.	D mm	H mm
44840	75	24	2KR	101	0,28	60	67873	75	100+5
44841	100	24	2KR	123,5	0,34	70	67874	100	130+2,5
44842	100	32	2KR	131,5	0,51	90	67874	125	155+2,5
44843	125	32	2KR	156,5	0,63	100			
44844	150	32	2KR	181,5	0,76	100			

#### PLASTIČNA RAZPORNNA PUŠA / PLASTIC EXPANDER FITTING VARIANTS:

Ident	Ident
Ø19-23 x 65 31029	☐ 21-24 x 65 45098
Ø23-26 x 68 29954	☐ 24-27 x 68 45099
Ø26-30 x 73 28252	☐ 27-31 x 74 45100
	☐ 31-35 x 85 45101
	☐ 35-40 x 85 45102

Naročanje: Ident kolesa in ident razporne puše.  
Ordering: Wheel id. and Expander id.

#### DODATKI / ACCESSORIES



#### RAZLIČICE - DODATKI / VARIETIES - ACCESSORIES



Zaščitni obroč  
Protective ring

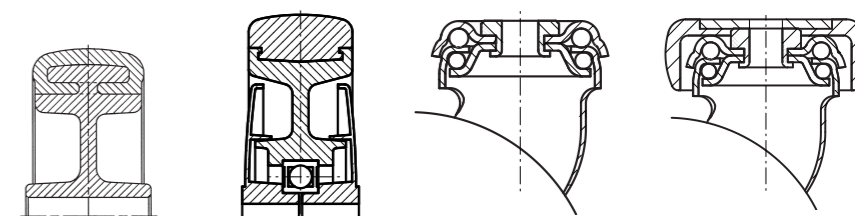



**KOLESA ZA  
POHIŠTVO**



**CASTORS  
AND WHEELS  
FOR FURNITURE**





### KOLESA

PLATIŠČE IZ POLIPROPILENA, GUMI OBROČ (83 ShA) ALI POLIETILEN OBLOGA (92 ShA), KOLO IZ POLIPROPILENA, DRSNI LEŽAJ.

### WHEELS

POLYPROPYLENE WHEEL CENTRE, RUBBER TYRE (83 ShA) OR POLYETHYLENE TREAD (92 ShA), POLYPROPYLENE SOLID WHEEL, PLAIN BEARING.



### KOLESA Z GIBLJIVIMI VILICAMI

CINKANE JEKLENE VILICE, PLATIŠČE IZ POLIPROPILENA, GUMI OBROČ (83 ShA) ALI POLIETILEN OBLOGA (92 ShA), KOLO IZ POLIPROPILENA, DRSNI LEŽAJ.

### SWIVEL CASTORS

ZINC ELECTRO-PLATED STEEL FORKS, POLYPROPYLENE WHEEL CENTRE, RUBBER TYRE (83 ShA) OR POLYETHYLENE TREAD (92 ShA), POLYPROPYLENE SOLID WHEEL, PLAIN BEARING.



#### Kolesa z gibljivimi vilicami - priroba / Swivel Castors - Top plate

ident.	ident.	ident.	D mm	C mm		F mm	W mm	kg	kg	ident.	ident.	ident.	D mm	C mm		AxB mm	axb mm	L mm	O mm	H mm	kg	kg
33963			50	24	≡	6	27,5	0,05	40	39293			50	24	≡	60x60	46x46	6,5	25	68	0,20	40
	33863		50	25	≡	6	27,5	0,05	60		33983		50	25	≡	60x60	46x46	6,5	25	68	0,20	60
		32533	50	25	≡	6	27,5	0,02	60			32553	50	25	≡	60x60	46x46	6,5	25	68	0,15	60
91797			75	25	≡	6	27,5	0,07	50	91866			75	25	≡	60x60	46x46	6,5	35	96	0,25	50
	33334		75	25	≡	6	27,5	0,07	75		33475		75	25	≡	60x60	46x46	6,5	35	96	0,25	75
		33954	75	25	≡	6	27,5	0,05	75			34954	75	25	≡	60x60	46x46	6,5	35	96	0,29	75
32324			100	25	≡	6	27,5	0,10	60	32313			100	25	≡	60x60	46x46	6,5	31	120	0,30	60
	33834		100	25	≡	6	27,5	0,10	80		33945		100	25	≡	60x60	46x46	6,5	31	120	0,30	80
		33653	100	25	≡	6	27,5	0,07	80			33645	100	25	≡	60x60	46x46	6,5	31	120	0,34	80

#### Kolesa z gibljivimi vilicami - luknja 10,5 / Swivel Castors - Single bolt housing 10,5

ident.	ident.	ident.	D mm	C mm		L mm	O mm	H mm	kg	kg
39294			50	24	≡	10,5	25	68	0,20	40
	39295		50	25	≡	10,5	25	68	0,20	60
		39305	50	25	≡	10,5	25	68	0,15	60
39173			75	25	≡	10,5	35	96	0,25	50
	39174		75	25	≡	10,5	35	96	0,25	75
		40734	75	25	≡	10,5	35	96	0,27	75
39184			100	25	≡	10,5	31	120	0,30	60
	39185		100	25	≡	10,5	31	120	0,30	80
		40735	100	25	≡	10,5	31	120	0,32	80

#### RAZLIČICE - DODATKI / VARIETIES - ACCESSORIES

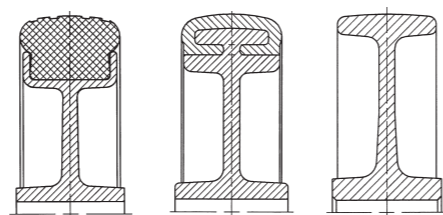

Obloga: guma  
Tread: rubber

Obloga: polietilen  
Tread: polyethylene

Obloga: brez  
Tread: solid wheel

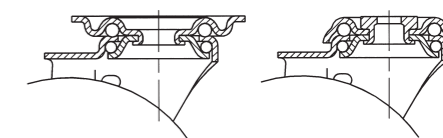



### KOLESA Z GIBLJIVIMI VILICAMI

CINKANE JEKLENE VILICE, PLATIŠČE IZ POLIPROPILENA, GUMI OBROČ (83 ShA) ALI POLIETILEN OBLOGA (92 ShA), DRSNI LEŽAJ.

### SWIVEL CASTORS

ZINC ELECTRO-PLATED STEEL FORKS, POLYPROPYLENE WHEEL CENTRE, RUBBER TYRE (83 ShA) OR POLYETHYLENE TREAD (92 ShA), PLAIN BEARING.



Kolesa z gibljivimi vilicami - priroba / Swivel Castors - Top plate

ident.	ident.	D mm	C mm	AxB mm	axb mm	L mm	O mm	H mm	kg	kg
91867		75	25	60x60	46x46	6,5	35	96	0,25	50
	32333	75	25	60x60	46x46	6,5	35	96	0,25	75
32314		100	25	60x60	46x46	6,5	31	120	0,30	60
	32325	100	25	60x60	46x46	6,5	31	120	0,30	80

Kolesa z gibljivimi vilicami - luknja 10,5 / Swivel Castors - Single bolt housing 10,5

ident.	ident.	D mm	C mm	L mm	O mm	H mm	kg	kg
39175		75	25	10,5	35	96	0,25	50
	39183	75	25	10,5	35	96	0,25	75
39193		100	25	10,5	31	120	0,30	60
	39194	100	25	10,5	31	120	0,30	80

### RAZLIČICE - DODATKI / VARIETIES - ACCESSORIES



Obloga: guma  
Tyre: rubber

Obloga: polietilen  
Tread: polyethylene

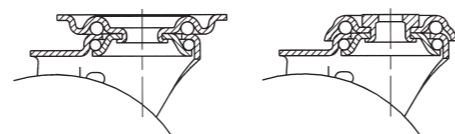

### KOLESA Z GIBLJIVIMI VILICAMI

CINKANE JEKLENE VILICE, PLATIŠČE IZ POLIPROPILENA, GUMI OBROČ (83 ShA) ALI POLIETILEN OBLOGA (92 ShA), KOLO IZ POLIPROPILENA, DRSNI LEŽAJ.

### SWIVEL CASTORS

ZINC ELECTRO-PLATED STEEL FORKS, POLYPROPYLENE WHEEL CENTRE, RUBBER TYRE (83 ShA) OR POLYETHYLENE (92 ShA) TREAD, POLYPROPYLENE SOLID WHEEL, PLAIN BEARING.



Kolesa z gibljivimi vilicami - priroba / Swivel Castors - Top plate

ident.	ident.	ident.	D mm	C mm	AxB mm	axb mm	L mm	O mm	H mm	kg	kg
35274			50	24	60x60	46x46	6,5	25	68	0,23	40
	34815		50	25	60x60	46x46	6,5	25	68	0,25	60
		35073	50	25	60x60	46x46	6,5	25	68	0,15	60
39055			75	25	60x60	46x46	6,5	35	96	0,31	50
	38734		75	25	60x60	46x46	6,5	35	96	0,27	75
		35113	75	25	60x60	46x46	6,5	35	96	0,29	75
39134			100	25	60x60	46x46	6,5	31	120	0,37	60
	38714		100	25	60x60	46x46	6,5	31	120	0,31	80
		35135	100	25	60x60	46x46	6,5	31	120	0,34	80

Kolesa z gibljivimi vilicami - luknja 10,5 / Swivel Castors - Single bolt housing 10,5

ident.	ident.	ident.	D mm	C mm	L mm	O mm	H mm	kg	kg
39303			50	24	10,5	25	68	0,21	40
	39304		50	25	10,5	25	68	0,23	60
		39313	50	25	10,5	25	68	0,15	60
39064			75	25	10,5	35	96	0,29	50
	38705		75	25	10,5	35	96	0,25	75
		40743	75	25	10,5	35	96	0,27	75
39135			100	25	10,5	31	120	0,35	60
	38725		100	25	10,5	31	120	0,29	80
		40744	100	25	10,5	31	120	0,32	80

### RAZLIČICE - DODATKI / VARIETIES - ACCESSORIES



Obloga: guma  
Tyre: rubber

Obloga: polietilen  
Tread: polyethylene

Obloga: brez  
Tread: solid wheel

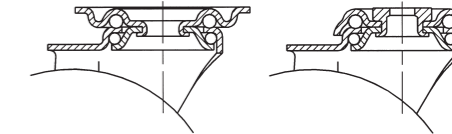





**KOLESA Z GIBLJIVIMI VILICAMI Ø 45**  
CINKANE JEKLENE VILICE, PLASTIČNO KOLO, DRSNI LEŽAJ.

**SWIVEL CASTORS Ø 45**  
ZINC ELECTRO-PLATED STEEL FORKS, PLASTIC SOLID WHEEL, PLAIN BEARING.



**DVOKOLESA Z GIBLJIVIMI VILICAMI**  
CINKANE JEKLENE VILICE, KOLO IZ POLIAMIDA, DRSNI LEŽAJ.

**TWIN WHEEL SWIVEL CASTORS**  
ZINC ELECTRO-PLATED STEEL FORKS, POLYAMIDE SOLID WHEEL, PLAIN BEARING.



**Priroba / Top Plate**

ident.	D mm	C mm	AxB mm	axb mm	L mm	O mm	H mm	kg	kg
91251	45	29	42x42	32x32	4,7	20	63	0,15	50

**Kolesa brez vilic / Wheels**

ident.	D mm	C mm	F mm	W mm	kg	kg
33674	50	18	8	22	0,02	60

**Luknja 8,5 / Single bolt housing 8,5**

ident.	D mm	C mm	L mm	O mm	H mm	kg	kg
25310	45	29	8,5	20	60	0,11	50

**Kolesa z gibljivimi vilicami - priroba / Swivel Castors - Top Plate**

ident.	ident.	D mm	C mm	AxB mm	axb mm	L mm	O mm	H mm	kg	kg
33663	39314	2x50	2x17,5	60x60	46x46	6,5	32	72	0,25	80

**Vijak 1/2" - 20UNF / Threaded Stem Housing 1/2"-20UNF**

ident.	D mm	C mm	MxL mm	O mm	H mm	kg	kg
65656	45	29	1/2"-20UNF x 14mm	20	65	0,14	50

**Kolesa z gibljivimi vilicami - luknja 10,5 / Swivel Castors - Single bolt housing 10,5**

ident.	ident.	D mm	C mm	L mm	O mm	H mm	kg	kg
33673	39315	2x50	2x17,5	10,5	32	72	0,22	80

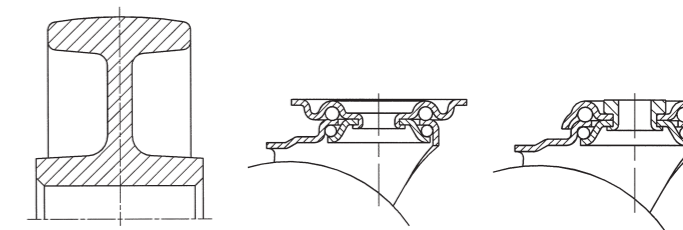
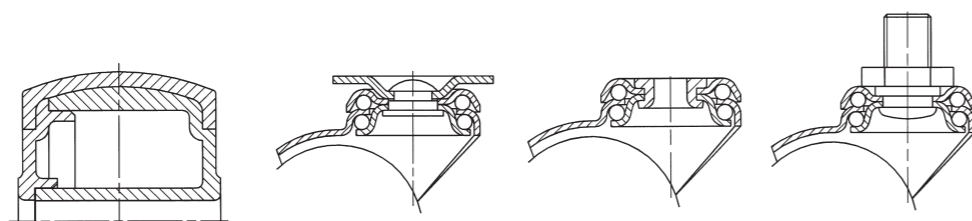



**TEMPERATURNO  
ODPORNA  
KOLESA**



**HEAT RESISTANT  
CASTORS  
AND WHEELS**







## KOLESA Z VILICAMI

CINKANE JEKLENE VILICE, KOLO IZ POLIAMIDA S STEKLENIMI VLAKNI,  
DRSNI ALI KROGLIČNI LEŽAJ.

+250°C

## SWIVEL AND FIXED CASTORS

ZINC ELECTRO-PLATED STEEL FORKS, GLASS REINFORCED POLYAMID WHEEL,  
PLAIN BEARING OR BALL BEARING.

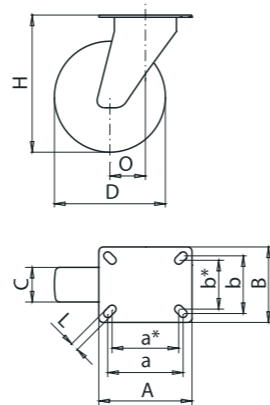

### Kolesa brez vilic / Wheels

Ident	D mm	C mm	Icon	F mm	W mm	kg	kg
44906	80	35	Icon	12	45	0,12	150
44907	100	35	Icon	12	45	0,18	170
44908	100	35	Icon	8	45	0,22	170
44909	125	38	Icon	12	45	0,27	200

### Kolesa z gibljivimi vilicami / Swivel Castors

Ident	D mm	C mm	Icon	A x B mm	a/a* x b/b* mm	L mm	O mm	H mm	kg	kg
44911	80	35	Icon	105x85	85/75x65/55	9	35	106	0,61	150
44912	100	35	Icon	105x85	85/75x65/55	9	40	128	0,72	170
44913	100	35	Icon	105x85	85/75x65/55	9	40	128	0,76	170
44914	125	38	Icon	105x85	85/75x65/55	9	40	155	0,86	200

### Kolesa s stabilnimi vilicami / Fixed Castors

Ident	D mm	C mm	Icon	A x B mm	a/a* x b/b* mm	L mm	H mm	kg	kg
44916	80	35	Icon	105x85	85/75x65/55	9	106	0,44	150
44917	100	35	Icon	105x85	85/75x65/55	9	128	0,52	170
44918	100	35	Icon	105x85	85/75x65/55	9	128	0,56	170
44919	125	38	Icon	105x85	85/75x65/55	9	155	0,64	200

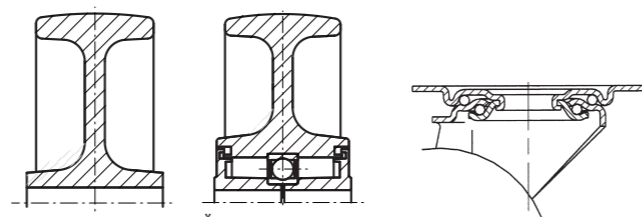

Blank lined area for notes or calculations.





**POSEBNE  
IZVEDBE  
KOLES**



**CASTORS  
AND WHEELS  
FOR SPECIAL  
REQUIREMENTS**





1



2



3



10



11



12



4



5



6



13



14



7



8



9

Posebne izvedbe koles kot variacije na standardna kolesa razvijamo po željah kupcev. Posebne izvedbe varirajo v sistemu zaviranja kolesa ali prirobe (smerna zavora), širine vilic, vgradne višine, dimezije prirobe, lastnosti materialov kolesa, nosilnosti ...

The special solutions as variations of standard castors upon consumer requirements can be developed by given technical description. Special castors vary in braking, locking system (directional locking device), fork width, overall height, top plate dimensions, material properties, load capacity...



NAŠA KOLESA SO SESTAVLJENA  
IZ ŠTIRIH RAZLIČNIH MATERIALOV:  
GUME, PLASTIKE, ALUMINIJA IN JEKLA.  
TE MATERIALE JE MOGOČE PONOVRNO UPORABITI,  
ZATO VAM PREDLAGAMO,  
DA ODSLUŽENA KOLESA ODDATE  
ZBIRALCEM SEKUNDARNIH SUROVIN.

OUR WHEELS AND CASTORS  
ARE MANUFACTURED BY FOUR RECYCABLE MATERIALS:  
RUBBER, PLASTIC, ALUMINIUM AND STEEL.  
ALL OF THEM CAN BE REPRODUCED,  
SO WE PROPOSE FOR ALL UNNSSED WHEELS AND CASTORS  
TO BE REMOVED TO THE COLECTORS  
OF SECONDARY MATERIALS.

**Алматы** (7273)495-231  
**Ангарск** (3955)60-70-56  
**Архангельск** (8182)63-90-72  
**Астрахань** (8512)99-46-04  
**Барнаул** (3852)73-04-60  
**Белгород** (4722)40-23-64  
**Благовещенск** (4162)22-76-07  
**Брянск** (4832)59-03-52  
**Владивосток** (423)249-28-31  
**Владикавказ** (8672)28-90-48  
**Владимир** (4922)49-43-18  
**Волгоград** (844)278-03-48  
**Волгодда** (8172)26-41-59  
**Воронеж** (473)204-51-73  
**Екатеринбург** (343)384-55-89

**Иваново** (4932)77-34-06  
**Ижевск** (3412)26-03-58  
**Иркутск** (395)279-98-46  
**Казань** (843)206-01-48  
**Калининград** (4012)72-03-81  
**Калуга** (4842)92-23-67  
**Кемерово** (3842)65-04-62  
**Киров** (8332)68-02-04  
**Коломна** (4966)23-41-49  
**Кострома** (4942)77-07-48  
**Краснодар** (861)203-40-90  
**Красноярск** (391)204-63-61  
**Курск** (4712)77-13-04  
**Курган** (3522)50-90-47  
**Липецк** (4742)52-20-81

**Магнитогорск** (3519)55-03-13  
**Москва** (495)268-04-70  
**Мурманск** (8152)59-64-93  
**Набережные Челны** (8552)20-53-41  
**Нижний Новгород** (831)429-08-12  
**Новокузнецк** (3843)20-46-81  
**Ноябрьск** (3496)41-32-12  
**Новосибирск** (383)227-86-73  
**Омск** (3812)21-46-40  
**Орел** (4862)44-53-42  
**Оренбург** (3532)37-68-04  
**Пенза** (8412)22-31-16  
**Петрозаводск** (8142)55-98-37  
**Псков** (8112)59-10-37  
**Пермь** (342)205-81-47

**Ростов-на-Дону** (863)308-18-15  
**Рязань** (4912)46-61-64  
**Самара** (846)206-03-16  
**Санкт-Петербург** (812)309-46-40  
**Саратов** (845)249-38-78  
**Севастополь** (8692)22-31-93  
**Саранск** (8342)22-96-24  
**Симферополь** (3652)67-13-56  
**Смоленск** (4812)29-41-54  
**Сочи** (862)225-72-31  
**Ставрополь** (8652)20-65-13  
**Сургут** (3462)77-98-35  
**Сыктывкар** (8212)25-95-17  
**Тамбов** (4752)50-40-97  
**Тверь** (4822)63-31-35

**Тольятти** (8482)63-91-07  
**Томск** (3822)98-41-53  
**Тула** (4872)33-79-87  
**Тюмень** (3452)66-21-18  
**Ульяновск** (8422)24-23-59  
**Улан-Удэ** (3012)59-97-51  
**Уфа** (347)229-48-12  
**Хабаровск** (4212)92-98-04  
**Чебоксары** (8352)28-53-07  
**Челябинск** (351)202-03-61  
**Череповец** (8202)49-02-64  
**Чита** (3022)38-34-83  
**Якутск** (4112)23-90-97  
**Ярославль** (4852)69-52-93

Россия +7(495)268-04-70

Казахстан +7(7172)727-132

Киргизия +996(312)96-26-47

<https://liv.nt-rt.ru/> || [vis@nt-rt.ru](mailto:vis@nt-rt.ru)